

**Model: JPD-FR300**

**CE**0482

**JUMPER**

**Infrared Thermometer  
Instruction Manual**

**Shenzhen Jumper Medical Equipment Co., Ltd.**

Manual Version: 1.0  
Date of Issue: 2020/04



# Content

|         |    |
|---------|----|
| EN..... | 1  |
| DE..... | 34 |
| FR..... | 50 |
| IT..... | 65 |
| ES..... | 81 |

**Product Information**

Product Name: Infrared Thermometer

Model:JPD-FR300

Manufacturer: Shenzhen Jumper Medical Equipment Co., Ltd

Address: D Building, No. 71, Xintian Road, Fuyong Street, Baoan, Shenzhen, Guangdong, China.

**Copyright**

Copyright © Jumper Medical.

All rights reserved.

**Statement**

Shenzhen Jumper Medical Equipment Co., Ltd. owns and reserves all of the rights comprised in the copyright of this document. No part of this document may be changed, excerpted, copied, reproduced, or imitated in any form or by any means without the prior consent of Shenzhen Jumper Medical Equipment Co., Ltd.

All statements, information, and recommendations in this document are provided "AS IS" without warranties, guarantees or representations of any kind, either express or implied. The information in this document is subject to change without notice. Shenzhen Jumper Medical Equipment Co., Ltd. reserves the right of final interpretation of this document.

**Introduction**

Thank you for purchasing this Infrared Thermometer. Please read the User Manual carefully to make sure safe and proper use of this thermometer.

Please read and fully understand the Safety Precautions before use.

**Keep the Instruction Manual with this thermometer for future reference.**

## Unpacking Check

Please open the package carefully before use, check whether all accessories are available or not and whether any component is damaged during transportation, and perform installation and operation following this user manual. In case of any damage or operation problem, please contact the dealer or contact Jumper directly. You will need the following information when making your claim: device model, serial number, purchase date, and your contact information and address.

## Package Contents

| No. | Name                 | Quantity |
|-----|----------------------|----------|
| 1   | Infrared Thermometer | 1        |
| 2   | Pouch                | 1        |
| 3   | Battery (AAA)        | 2        |
| 4   | Instruction Manual   | 1        |

## Safety Precautions

**Read the following precautions carefully before using the thermometer.**











|  <b>Attention</b> |  |
|---|--|
| ◆   | Take care of the temperature probe lens, which is fragile.   |
| ◆   | Dispose used batteries with care. To protect the environment, you are recommended to send the used batteries to a designated collection point. |
| ◆   | Remove the batteries if the thermometer will not be used for more than two months.   |
| ◆   | Do not immerse the thermometer in water or expose it to direct sunlight.   |

|   |   |
|---|---|
| ◆ | Do not subject the thermometer to vibration or impact.  |
| ◆ | The normal body temperature varies from person to person. Tracking a person's body temperature will help determine whether they have fever.   |
| ◆ | Do not take body temperature readings within 20 minutes after you do physical exercises or get excited.   |
| ◆ | Clean the thermometer probe after each use.   |
| ◆ | Do not use the thermometer on newborns or for continuous temperature monitoring purposes.   |
| ◆ | Do not use the thermometer for purposes that are not specified in this User's Manual. Follow the instructions in the "Measurement Process" chapter and carefully operate the thermometer when measuring children's temperature. |
| ◆ | Do not immerse the thermometer in water or other liquid, as it is not waterproof. Clean and disinfect the thermometer as described in the "Cleaning and Disinfection" chapter.  |
| ◆ | Do not touch the tip of the temperature probe, on which a precise temperature sensor resides.   |
| ◆ | Keep the temperature probe clean to make sure accurate readings.  |
| ◆ | Before measuring the temperature from the ear canal, clean the earwax, if any.  |
| ◆ | The ambient temperature must not be extremely high or low. To make sure accurate readings, keep the thermometer under room temperature for more than 30 minutes before use.   |
| ◆ | Do not use the thermometer under an ambient temperature higher than 40°C (104°F) or lower than 10°C (50°F), which is beyond the operating temperature range of the thermometer.   |
| ◆ | <b>Risk of pollution!</b> The user is recommended to send the overdue thermometer to local garbage disposal site or send it back to us.   |
| ◆ | 2 AAA batteries of 1.5V are the only replaceable accessories of the thermometer. Please do not use the batteries of other voltages or specifications.   |

**Warning**

|  <b>Warning</b> |   |
|--|---|
| ●  | Do not force the temperature probe of the thermometer into an ear canal. Otherwise, the ear canal may get injured.                                |
| ●  | Keep the thermometer out of the reach of children.  |
| ●  | The result may be inaccurate if you use the overdue thermometer.  |
| ●  | The thermometer is not intended to diagnose or treat any health problem or disease. The measurement results are for reference only.               |
| ●  | It is dangerous to make a self-diagnosis or self-treatment based on the obtained measurement results. For such purposes, please consult a doctor. |
| ⊘  | Do not charge an alkaline dry-cell battery or throw it in fire. Otherwise, the battery may explode.   |
| ⊘  | Do not disassemble the thermometer or attempt to repair it. Otherwise, the thermometer may be damaged permanently.                                |
| ⊘  | Do not take temperature measurements on body parts other than forehead and ears. Otherwise, the temperature readings may be inaccurate.           |
| ⊘  | During measurement, do not use a mobile phone or any other device that may cause electromagnetic interference.                                    |
| ⊘  | Do not use the thermometer in an environment where flammable anesthetic mixture with air or with oxygen or nitrous oxide is available.            |

## Symbols

| Symbol  | Description   |
|---|---|
|            | Type BF applied part.   |
|            | Attention must be paid.   |
|            | The action is prohibited.   |
|            | Information about the manufacturer.   |
|            | Date of manufacture.  |
|            | Consult the instructions for use.   |
|            | This product complies with the MDD93/42/EEC requirements.   |
|            | Waste electrical materials should be sent to a dedicated collection point for recycling.            |
| IP22  | Degree of protection against the Ingress of water.  |
|  Warning   | A personal injury or damage to the thermometer may occur if the thermometer is not used correctly.  |
|  Attention | Inaccurate reading or damage to the thermometer may occur if the thermometer is not used correctly. |

## Body Temperature Basics

- The normal body temperature is a range.
- The normal range varies from person to person and can fluctuate throughout the day.
- The normal range also varies by body site. Therefore, measurements



from different sites should not be compared directly.

To determine if an individual is experiencing an elevated body temperature and/or having a fever, it is critical to know the individual's normal body temperature when he/she is well. Take multiple readings to obtain the normal body temperature range and note the specific body site measured, for example: forehead or eardrum temperature.

| Body Part | Normal Temperature Range       |
|-----------|--------------------------------|
| Forehead  | 34.7°C–37.3°C / 94.5°F–99.1°F  |
| Ear canal | 35.8°C–38.0°C / 96.4°F–100.4°F |
| Mouth     | 35.3°C–37.5°C / 95.9°F–99.5°F  |
| Armpit    | 34.7°C–37.3°C / 94.5°F–99.1°F  |
| Anus      | 36.6°C–38.0°C / 97.9°F–100.4°F |

The normal body temperature range slightly varies with age and gender. Generally, newborns or children have higher body temperature than adults, and adults have higher body temperature than the elderly. Women's body temperature are appropriately 0.3° C (0.5 ° F) higher than men's.

### Variation in body temperature

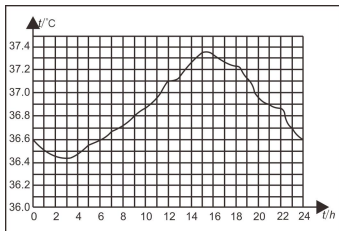

Normal body temperature fluctuates throughout the day and is also affected by external factors. The body temperature of an individual is the lowest between 2:00 a.m. and 4:00 a.m. and the highest between 2:00 p.m. and 8:00 p.m. An individual's body temperature typically changes by less than 1°C (1.8°F) each day.

## Product Description

### 1) Overview

Infrared Thermometer JPD-FR300 measures the body temperature based on the infrared energy emitted from the eardrum or the forehead. Users can quickly get measurement results after positioning properly the temperature probe in the ear canal or forehead. It can also be used to measure the surface temperature of object. (such as milk and water)

### 2) Structure

The thermometer consists of a shell, an LCD, a measure button, a beeper, an infrared temperature sensor, and a Microprocessor.

### 3) Operating principle

The infrared temperature sensor collects infrared energy emitted by the eardrum or the skin surface. After being focused by a lens, the energy is converted into a temperature reading by the thermopiles and measurement circuits.

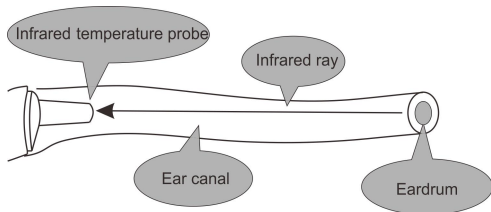

### 4) Intended use

The JPD-FR300 Dual Mode Digital Infrared Thermometer is intended for the measurement of human body temperatures. The forehead mode is indicated for use by people of all ages and the eardrum mode is indicated for use by people above three months old.

### 5) Contraindications

Do not use the thermometer if the ear is infected with otitis or suppuration.

## Features

- 01 Good safety
  - Passive infrared receiving technology.
- 02 Easy operation
  - Ergonomic design
  - One button measurement
- 03 Quick measurement
  - 1-second measurement
- 04 High accuracy
  - Advanced infrared temperature sensor, with high sensitivity
  - High accuracy with automatic temperature calibration
- 05 Diverse functions
  - 20 readings recall
  - Fever alert
  - Switching between °C and °F
  - Automatic power-off, power saving
- 06 Extensive application scope
  - Forehead temperature measurement applicable to all age groups
  - Ear temperature measurement applicable to children older than three months, adults, and the elderly
- 07 Child mode

This mode is recommended for people under 12 years of age.

## Product structure

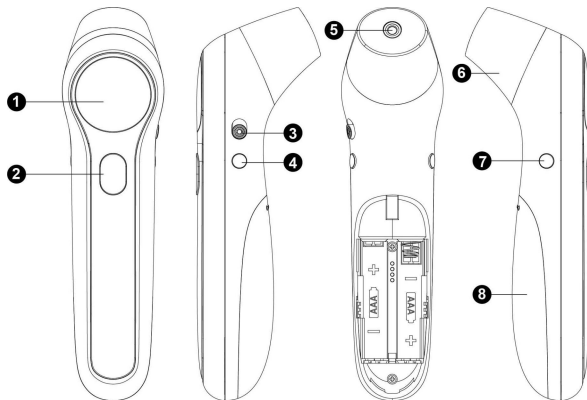

- (1) LCD display screen
- (2) Power button / Measure button
- (3) Unit switch button (°C / °F)
- (4) Mode button (Adult mode / Child mode / Object)
- (5) Probe (take off the cover when measuring the ear temperature)
- (6) Probe cover (Automatic switch among object, forehead and ear modes, by removing the probe cover to measure ear temperature and placing back the probe cover for object and forehead temperature measurement.)
- (7) Memory button / Sound switch
- (8) Battery cover

## Display description

1. Object temperature mode
2. Forehead temperature mode
3. Child mode
4. Ear temperature mode
5. Mute / un-mute
6. Temperature unit (°C / °F)

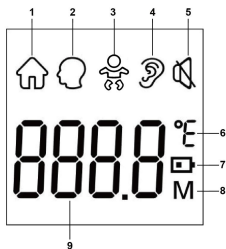

7. Low battery
8. Memory recall
9. Temperature value



## Sounds and backlight color instructions





| Range                                | Sounds               | Backlight |
|--------------------------------------|----------------------|-----------|
| Forehead temperature (Adult / Child) |                      |           |
| 35.0°C-37.5°C/95.0°F-99.5°F          | A long beep          | green     |
| 37.6°C-42.2°C/99.6°F-108.0°F         | 3 short double beeps | Red       |
| Ear temperature (Adult / Child)      |                      |           |
| 35.0°C-37.5°C/95.0°F-99.5°F          | A long beep          | green     |
| 37.6°C-42.0°C/99.6°F-107.6°F         | 3 short double beeps | Red       |
| Object temperature                   |                      |           |
| 0°C-100°C/32.0°F-212°F               | A long beep          | green     |





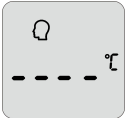

**Note:** When the forehead and the ear temperature is between 35.0°C/95.0°F and 37.5°C/99.5°F, there will be a long beep and a green backlight. This indicates that your body temperature is normal.

When the forehead temperature is between 37.6°C/99.6°F and 42.2°C/108.0°F, and the ear temperature is between 37.6°C/99.6°F and 42.0°C/107.6°F, there will be 3 short double beeps and a red backlight. This indicates that your body temperature is a little high. You may have a fever. Please consult your doctor if you are not sure.

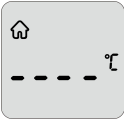





## Display and Operating Instructions



| Screen Display   | Operating Instructions<br>Displayed State   | Sound and<br>Backlight Color   |
|--|---|--|
| Measuring Ear temperature (Adult / Child)  |   |  |
|  <p data-bbox="135 794 299 848">Ear temperature<br/>for adult</p> <p data-bbox="135 1030 299 1084">Ear temperature<br/>for child</p> | <p data-bbox="310 525 698 681">Take off the probe cover, press and release the <b>Power button</b> for 1 second to power on the thermometer. The symbol “” is displayed on the screen.</p> <p data-bbox="310 695 698 812">Switch to the adult or child measurement mode by dialing the side adult/child switcher according to your measurement needs.</p> <p data-bbox="310 827 698 943">Insert the temperature probe into a proper position in the ear canal. Press the <b>Measure button</b> to start a measurement.</p> | <p data-bbox="699 661 906 806">See the table in the “Sounds and backlight color instructions” section.</p> |
| Measuring Forehead temperature (Adult / Child)   |   |  |

| Screen Display   | Operating Instructions<br>Displayed State   | Sound and<br>Backlight Color   |
|--|---|--|
|  <p style="text-align: center;">↓</p>  <p style="text-align: center;">Forehead<br/>temperature for<br/>adult</p>  <p style="text-align: center;">Forehead<br/>temperature for<br/>child</p> | <p>Put the cover on the probe, press and release the <b>Power button</b> for 1 second to power on the thermometer. The “Head” symbol  is displayed on the screen.</p> <p>Switch to the adult or child  measurement mode by dialing the side adult/child switcher according to your measurement needs.</p> <p>Point the thermometer to the center of the forehead, about “1-3cm” away from the skin surface. Press and release the <b>Measure button</b>. The temperature will be displayed on the screen.</p> | <p>See the table in the “Sounds and backlight color instructions” section.</p> |
| Measuring Object temperature   |   |  |



| Screen Display  | Operating Instructions<br>Displayed State  | Sound and<br>Backlight Color   |
|---|--|--|
| <br><br> | <p>Put the cover on the probe, switch to the object measurement mode by pressing the <b>Mode button</b>. The thermometer enters the <b>Object mode</b>. The “House” symbol  is displayed on the screen.</p> <p>Point the thermometer to the center of the object. Press and release the <b>Measure button</b>. The temperature will be displayed on the screen.</p> | <p>See the table in the “Sounds and backlight color instructions” section.</p> |
| Out of the measuring range display  |  |  |
| <br>(for reference only)   | <p>In Ear mode, a temperature reading of more than 42.0°C (107.6°F)</p> <p>In Forehead mode, a temperature reading of more than 42.2°C (108.0°F)</p> <p>In Object mode, a temperature reading of more than 100°C (212.0°F)</p>   | <p>A long beeps, the backlight is red.</p>                                     |
| <br>(for reference only)   | <p>In Ear mode, a temperature reading of less than 35.0°C (95.0°F)</p> <p>In Forehead mode, a temperature reading of less than 35.0°C (95.0°F)</p> <p>In Object mode, a temperature reading of less than 0°C (32.0°F)</p>  | <p>A long beeps, the backlight is red.</p>                                     |
| Recall 20 memories  |  |  |

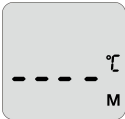
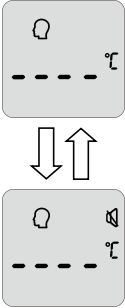

| Screen Display   | Operating Instructions<br>Displayed State  | Sound and<br>Backlight Color           |
|--|--|--|
| <br><br><br><br><br><br> | <p>In a power-on state, press the <b>Memory button</b> enter the memory mode.</p> <p>When the <b>Memory button</b> is released, <b>01</b> will be shown, followed by the recorded reading.</p> <p>Press the <b>Memory button</b> again for the next recorded data. <b>02</b> will be shown, followed by the recorded reading.</p> <p>A maximum of 20 temperature readings can be recalled.</p> <p>When the maximum number of records is exceeded, the earliest memory data will be overwritten.</p> <p><b>Note:</b><br/><b>01</b> means the latest data.</p> | <p>Silent, the backlight is green.</p> |
| No memory data / Clear memory data   |  |  |

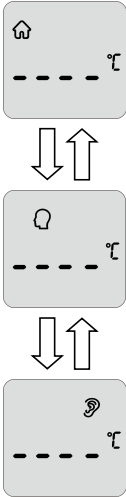
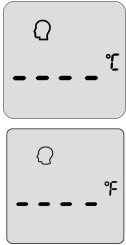
| Screen Display  | Operating Instructions<br>Displayed State   | Sound and<br>Backlight Color   |
|---|---|--|
|  | <p>The display is as shown, when there is no more data checked while recalling memories. Remove 2 dry batteries and after 10 seconds re-install the power to clear all memory data.</p>   | <p>When the power is turned back on, there are a long beep and a green backlight, which then turns into red.</p> |
| Switching between mute and un-mute  |   |  |
|  | <p>In the power-on state, press and hold the sound switch button for about 2 seconds to switch the sound on or off. When the sound is turned on, it will beep once and the mute symbol will be displayed when the sound is off.</p> <p>The  symbol is displayed in Mute mode and disappears in Un-mute mode.</p> | <p>When the sound is turned on, it sounds a long beep and the backlight is green.</p>                            |
| Switching between object temperature and body temperature                         |   |  |

| Screen Display   | Operating Instructions<br>Displayed State   | Sound and<br>Backlight Color           |
|--|---|--|
|   | <p>When putting on the probe cover, press the <b>Mode button</b> to switch between object and forehead modes. Ear mode (adult/child) will be activated by removing the probe cover.</p> | <p>Silent, the backlight is green.</p> |
| Switching between °F/°C  |   |  |
|  | <p>In a power-on state, you can change units, by switching the <b>°F/°C button</b>.</p>   | <p>Silent</p>                          |

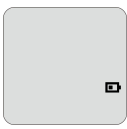
| Screen Display  | Operating Instructions<br>Displayed State  | Sound and<br>Backlight Color               |
|---|--|--|
| Error information & low battery   |  |  |
|  | <p>The ambient temperature is higher than 40.0°C (104.0°F) or lower than 10.0°C (50.0°F).</p>  | <p>A long beeps, the backlight is red.</p> |
|  | <p>An error occurs when data is being read from or written to the memory, or the temperature correction is not complete.</p>                               | <p>A long beeps, the backlight is red.</p> |
|  | <p>When the battery voltage is lower than <math>2.4V \pm 0.1V</math>, the low battery symbol will appear on the display. Please replace the batteries.</p> | <p>Silent</p>                              |

## Measuring Ear Temperature

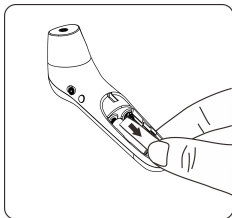
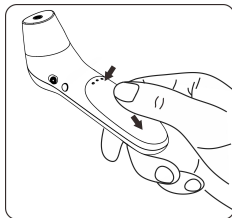

1. When using the thermometer for the first time, move the battery's insulating piece away.

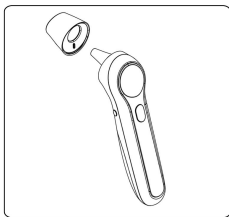

2. Take the probe cover off from the thermometer before measuring the

ear temperature.



3. Press the **Power button** to power on the thermometer. The “Ear”  symbol is displayed on the screen.
4. Switch between “adult” and “child” modes by pressing Mode button.  symbol shows up in “child” mode.
5. Insert the temperature probe into the ear canal.
6. Press and release the **Measure button**. The ear temperature reading will be display on the screen instantly.

**Note:** Children under 1 year: Pull the ear straight back.

Children aged 1 year to adult: Pull the ear up and back.

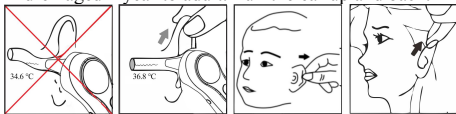

Do not force the thermometer into the ear canal. Otherwise, the ear canal may get injured.



When taking the temperature on an adult, gently pull the ear up and back to make sure the ear canal is straight, so that the temperature probe can receive an infrared ray from the eardrum.



Be careful when taking temperature on a child, whose ear canal is small.

## Measuring Forehead Temperature

1. Put the cover on the probe of thermometer.
2. Press the **Power button** to power on the thermometer. the “☁” symbol is displayed on the screen.
3. Switch between “adult” and “child” modes by pressing Mode button. ☁ symbol shows up in “child” mode.
4. Point the thermometer probe to the center of the forehead, about “1-3cm” away from the skin surface.

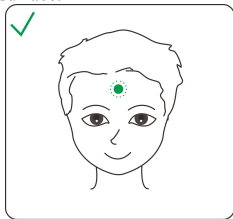
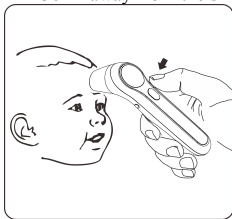

5. Press and release the **Measure button** for 1 second. The temperature reading will be displayed on the screen instantly.
6. If no activity is detected, the thermometer will power off automatically in 10 seconds.

## Measuring Object Temperature

1. Put the cover on the probe of thermometer.
2. Press the **Power button** to power on the thermometer.
3. Press the **Mode button**, the thermometer enters the **Object mode**. The “🏠” symbol is displayed on the screen.
4. Point the thermometer probe to the center of the object, about “1-3cm” away from the object surface.
5. Press and release the **Measure button** for 1 second. The temperature reading will be displayed on the screen instantly.
6. If no activity is detected, the thermometer will power off automatically in 10 seconds.

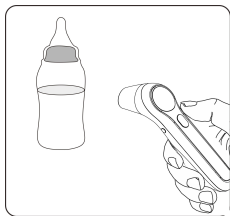

### After a measurement

- (1) After each measurement, you can enter the recall mode and query earlier temperature readings. For more details, see "Recall 20 memories" in the preceding table.
- (2) After each measurement, clean the temperature probe with a soft cloth, and put the thermometer in a dry and well-ventilated place.



It is dangerous to make a self-diagnosis or self-treatment based on the obtained measurement results. For such purposes, please consult a doctor.

### Notes:

- (1) The thermometer is suitable for an indoor environment without strong air convection (for example, winds from a fan, an air-conditioner, or a heater) between the thermometer and the person.
- (2) Make sure that the ear canal is clean and dry before starting a measurement. It is recommended to clean the ear canal with a cotton swab if any dirt exists. Otherwise, the temperature probe may be polluted and temperature readings may be inaccurate.
- (3) Do not hold the thermometer for a long time, because it is sensitive to the ambient temperature.
- (4) Make sure the sense head is free of foreign matters before use;
- (5) Make sure the forehead has no sweat and no hairs covered before measure the forehead temperature; otherwise, the result could be incorrect;

- (6) No intense emotion or strenuous exercises before measuring;
- (7) After measuring the data once, you should wait for the backlight to turn off and measure the next data.

## Replacing Batteries

- 1、Slide the battery cover off along the marked direction and take it off.
- 2、Insert the two AAA batteries into the compartment according to the stated polarities.

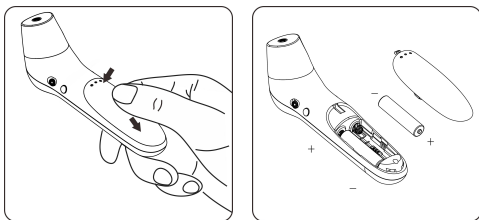

 Make sure that the batteries are installed correctly. Otherwise, the thermometer may be damaged.

 If the low-battery symbol is displayed on the screen, replace the batteries.

 Batteries of a same type should be used. Dispose the used batteries in accordance with the local environmental policies.

 The thermometer is shipped with batteries. First open the battery cover, then remove the insulating piece.



## Cleaning and Disinfection

### Cleaning

Recommended detergents:

- \* Medical detergents;
- \* Home use mild detergents;

Cleaning steps:

- (1) Take the batteries out before cleaning.
- (2) Clean the temperature probe with a

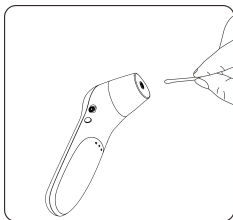

soft cloth. Clean the lens of the temperature probe with a cotton swab.

- (3) Wipe the thermometer body with a slightly damp soft cloth.



Keep water out of the lens during the cleaning process. Otherwise, the lens may be damaged.



The lens may be scratched if it is cleaned with a hard object, which might result in inaccurate readings.



Do not clean the thermometer with corrosive cleansers. During the cleaning process, do not immerse any part of the thermometer into liquid, or allow liquid to penetrate the thermometer.

### Disinfection

Recommended disinfectants:

- \* Isopropyl alcohol solution (concentration: 70%)
- \* Medicinal alcohol (concentration: 75%)
- \* Sodium hypochlorite solution (concentration: 3%)

Disinfecting steps:

- 1) Wet the clean soft cloth with a small quantity of disinfectant, wipe the thermometer and quickly dry it.
- 2) Disinfect the thermometer body and the area around the temperature probe with a cloth slightly moistened with 75% medical alcohol.



Do not use hot steam or ultraviolet radiation for disinfection.

Otherwise, the thermometer may be damaged or quickly aged.



It is recommended to disinfect the thermometer before and after each use. The disinfection time is completed within 1 minute, and the number of repetitions per disinfection is not more than 2 times.



Clean and disinfect the thermometer under the temperature of  $+10^{\circ}\text{C}\sim+40^{\circ}\text{C}$  ( $50^{\circ}\text{F}\sim104^{\circ}\text{F}$ ), the relative humidity of 15%~85%RH (no condensation) and the barometric pressure of 86kPa~106kPa.

## Maintenance

### Preventive inspection & maintenance period

- 1) Ensure the safety of thermometer, and check whether it has potential safety hazards in normal use each week, e.g. whether the lens is broken, the shell has cracks and the sensing head is polluted. Do not use the thermometer with potential safety hazard. Clean the thermometer if not used for a long time.
- 2) After each use, clean the temperature probe as described in the "Cleaning and Disinfection" chapter.
- 3) Store the thermometer in a dry, dust-free, and well-ventilated place. Make sure that the thermometer is not exposed to sunlight. Make sure that the storage and transportation environments meet the

requirements.

- 4) Check regularly whether safety risks exist.
- 5) Remove the batteries if the thermometer will not be used for more than two months.

## Troubleshooting

| Problem   | Possible Cause   | Solution  |
|---|--|---|
| The thermometer fails to power on.  | Low battery  | Change the batteries.   |
|   | Polarities of the batteries are reversed.  | Make sure that the batteries are installed correctly.                                   |
|   | The thermometer is damaged.  | Contact the manufacturer.   |
| "Er1" is displayed.   | The ambient temperature is lower than 10°C (50.0°F) or higher than 40°C (104°F).     | Take a measurement under an ambient temperature between 10°C (50.0°F) and 40°C (104°F). |
| The temperature reading is lower than the typical body temperature range. | The lens of the temperature probe is dirty.  | Clean the lens using a cotton swab.   |
|   | The thermometer probe is not aligned to the eardrum.                                 | Reposition the thermometer probe so that it is aligned to the eardrum.                  |
|   | The thermometer is used within 30 minutes after being taken from a cold environment. | Wait for more than 30 minutes after the thermometer is moved into the                   |

|  |                                   |                           |
|--|-----------------------------------|---------------------------|
|  |                                   | measurement environment.  |
| The temperature reading is higher than the typical body temperature range. | The temperature probe is damaged. | Contact the manufacturer. |

## Specifications

|                       |   |
|-----------------------|---|
| Product Name          | Infrared Thermometer  |
| Product Model         | JPD-FR300   |
| Power Supply Mode     | Internal power supply   |
| Operating Voltage     | DC 3V   |
| Battery Model         | AAA x 2   |
| Operating Mode        | Continuous operating  |
| Display               | Segment LCD   |
| Measure time          | About 1 second  |
| Latency Time          | About 3 second  |
| Measuring Range       | Forehead mode: 35.0°C–42.2°C (95.0°F–108.0°F)<br>Ear mode: 35.0°C–42.0°C (95.0°F–107.6°F)<br>Object mode: 0.0°C–100.0°C (32.0°F–212.0°F)  |
| Accuracy (Laboratory) | Forehead mode: $\pm 0.2^{\circ}\text{C}$ ( $\pm 0.4^{\circ}\text{F}$ )<br>Ear mode: $\pm 0.2^{\circ}\text{C}$ ( $\pm 0.4^{\circ}\text{F}$ )<br>Object mode: $\pm 1.0^{\circ}\text{C}/\pm 2.0^{\circ}\text{F}$ |
| Resolution            | 0.1°C (0.1°F)   |
| Memory                | 20 temperature readings   |
| Low-battery Alert     | The low-battery symbol is displayed if the power voltage is lower than 2.4 V $\pm$ 0.1V   |
| Automatic Power-off   | The thermometer automatically powers off if it is not used in 10 $\pm$ 1 seconds.   |

|                       |                                      |
|-----------------------|--------------------------------------|
| Outer dimensions (mm) | 155.9*40.2*49.2mm                    |
| Weight (g)            | Thermometer (with batteries): 90g    |
| Manufacturing date    | see the label                        |
| Operating Environment | Temperature: 10°C~ 40°C (50°F–104°F) |
|                       | Humidity: 15%–95% RH, non-condensing |
|                       | Atmospheric pressure: 86–106 kPa     |

The infrared thermometer has been tested and conforms to the standard ASTM E1965-98. ASTM laboratory accuracy requirements in the display range of 96.8°F to 102.2°F (36°C-39°C) for ear canal IR thermometers is  $\pm 0.4^\circ\text{F}$  ( $\pm 0.2^\circ\text{C}$ ). Note that for mercury-in-glass and electronic thermometers, the requirement per ASTM Standards E667-86 and E1112-86 is  $\pm 0.2^\circ\text{F}$  ( $\pm 0.1^\circ\text{C}$ ).

## Security Class

Type of protection against electric shock: internally powered equipment.

Degree of protection against electric shock:  Type BF applied part.

- Degree of protection against ingress of water: IP22
- Safety degree of using in flammable anesthetic gas blending with air, oxygen or nitrous oxide: Non-AP/APG
- No application parts of the thermometer prevents defibrillation charge effect.
- No application parts of the thermometer output signal.
- The thermometer is impermanent installed device.

## Storage and Transportation

The thermometer can be transported using general transportation tools. Severe vibration, shock, or rain must be avoided during transportation. The thermometer must be packaged and then stored in a well-ventilated room without corrosive gas. The ambient temperature must be between  $-20^{\circ}\text{C}$  and  $+55^{\circ}\text{C}$  ( $-4^{\circ}\text{F}$ – $131^{\circ}\text{F}$ ), the relative humidity must be lower than 95% (non-condensing), and the atmospheric pressure must be 50–106 kPa.

## EMC Information-Guidance and Manufacture's

### Declaration



#### CAUTION:

- The Infrared Thermometer JPD-FR300 needs special precautions regarding EMC and needs to be installed and put into service according to the EMC information provided for in the ACCOMPANYING DOCUMENTS.
- Portable and mobile RF communications equipment can affect Infrared Thermometer JPD-FR300.
- The Infrared Thermometer JPD-FR300 should not be used adjacent to or stacked with other equipment.

### Guidance and manufacturer's declaration – Electromagnetic emission –for all equipment and systems

|  |
|--|
| Guidance and manufacturer's declaration – Electromagnetic emission   |
| The Infrared Thermometer JPD-FR300 is intended for use in the electromagnetic environment specified below. The customer or the user of the Infrared Thermometer JPD-FR300 should assure that it is |

|                              |            |   |
|------------------------------|------------|---|
| used in such an environment. |            |   |
| Emissions test               | Compliance | Electromagnetic environment - guidance  |
| RF emissions CISPR 11        | Group 1    | The Infrared Thermometer JPD-FR300 uses RF energy only for its internal function. Therefore, its RF emissions are very low and are not likely to cause any interference in nearby electronic equipment.   |
| RF emissions CISPR 11        | Class B    | The Infrared Thermometer JPD-FR300 is suitable for use in all establishments, including domestic establishments and those directly connected to the public low-voltage power supply network that supplies buildings used for domestic purposes. |

### **Guidance and manufacturer's declaration – Electromagnetic immunity –for all equipment and systems**

|   |                       |                            |   |
|---|-----------------------|----------------------------|---|
| Guidance and manufacturer's declaration – Electromagnetic immunity  |                       |                            |   |
| The Infrared Thermometer JPD-FR300 is intended for use in the electromagnetic environment specified below. The customer or the user of the Infrared Thermometer JPD-FR300 should assure that it is used in such an environment. |                       |                            |   |
| Immunity test   | IEC 60601 test level  | Compliance level           | Electromagnetic environment- guidance   |
| Electrostatic discharge (ESD) IEC   | ±6kV contact<br>±8 kV | ±6 kV contact<br>±8 kV air | Floors should be wood, concrete or ceramic tile. If floors are covered with synthetic material, the |

|   |       |       |   |
|---|-------|-------|---|
| 61000-4-2   | air   |       | relative humidity should be at least 30 %.  |
| Power frequency (50/60 Hz) magnetic field IEC 61000-4-8 | 3 A/m | 3 A/m | Power frequency magnetic fields should be at levels characteristic of a typical location in a typical commercial or hospital environment. |

**Guidance and manufacturer's declaration – Electromagnetic immunity –for equipment and systems that are not life-supporting**

| Guidance and manufacturer's declaration – Electromagnetic immunity  |                                  |                  |  |
|---|----------------------------------|------------------|--|
| The Infrared Thermometer JPD-FR300 is intended for use in the electromagnetic environment specified below. The customer or the user of the Infrared Thermometer JPD-FR300 should assure that it is used in such an environment. |                                  |                  |  |
| Immunity test   | IEC 60601 test level             | Compliance level | Electromagnetic environment -guidance  |
| Radiated RF IEC 61000-4-3   | 3 V/m<br>80 MHz<br>to 2.5<br>GHz | 3 V/m            | Portable and mobile RF communications equipment should be used no closer to any part of the JPD-FR300,including cables, than the recommended separation distance calculated from the equation applicable to the frequency of the |



|  |  |  |   |
|--|--|--|---|
|  |  |  | <p>transmitter.</p> <p>Recommended separation distance</p> $d = \left[ \frac{3.5}{E_1} \right] \sqrt{P} \quad 80 \text{ MHz to } 800 \text{ MHz}$ $d = \left[ \frac{7}{E_1} \right] \sqrt{P} \quad 800 \text{ MHz to } 2.5 \text{ GHz}$ <p>where p is the maximum output power rating of the transmitter in watts (W) according to the transmitter manufacturer and d is the recommended separation distance in metres (m).</p> <p>Field strengths from fixed RF transmitters, as determined by an Electromagnetic <sup>a</sup> site survey, should be less than the compliance level in each frequency range.<sup>b</sup></p> <p>Interference may occur in the vicinity of equipment marked with the following symbol:</p>  |
|--|--|--|---|

NOTE 1 At 80 MHz and 800 MHz, the higher frequency range applies.

NOTE 2 These guidelines may not apply in all situations. Electromagnetic is affected by absorption and reflection from structures, objects and people.

a. Field strengths from fixed transmitters, such as base stations for radio (cellular/cordless) telephones and land mobile radios, amateur radio, AM and FM radio broadcast and TV broadcast cannot be predicted theoretically with accuracy. To assess the electromagnetic environment due to fixed RF transmitters, an electromagnetic site survey should be considered. If the measured field strength in the location in which the JPD-FR300 is used exceeds the applicable RF compliance level above, the JPD-FR300 should be observed to verify normal operation. If abnormal performance is observed, additional measures may be necessary, such as re-orienting or relocating the JPD-FR300.

b. Over the frequency range 150 kHz to 80 MHz, field strengths should be less than 3 V/m.

**Recommended separation distances between portable and mobile RF communications equipment and the EQUIPMENT or SYSTEM -for EQUIPMENT and SYSTEMS that are not LIFE-SUPPORTING**

The Infrared Thermometer JPD-FR300 is intended for use in an electromagnetic environment in which radiated RF disturbances are controlled. The customer or the user of the Infrared Thermometer JPD-FR300 can help prevent electromagnetic interference by maintaining a minimum distance between portable and mobile RF

|  |  |   |
|--|--|---|
| communications equipment (transmitters) and the Infrared Thermometer JPD-FR300 as recommended below, according to the maximum output power of the communications equipment.  |  |   |
| Rated maximum output power of transmitter W  | Separation distance according to frequency of transmitter<br>m     |   |
|  | 80 MHz to 800 MHz<br>$d = \left[ \frac{3.5}{E_1} \right] \sqrt{P}$ | 800 MHz to 2.5 GHz<br>$d = \left[ \frac{7}{E_1} \right] \sqrt{P}$ |
| 0.01   | 0.12   | 0.23  |
| 0.1  | 0.38   | 0.73  |
| 1  | 1.2  | 2.3   |
| 10   | 3.8  | 7.3   |
| 100  | 12   | 23  |
| <p>For transmitters rated at a maximum output power not listed above, the recommended separation distance <math>d</math> in metres (m) can be estimated using the equation applicable to the frequency of the transmitter, where <math>P</math> is the maximum output power rating of the transmitter in watts (W) according to the transmitter manufacturer.</p> <p>NOTE 1 At 80 MHz and 800 MHz, the separation distance for the higher frequency range applies.</p> <p>NOTE 2 These guidelines may not apply in all situations. Electromagnetic propagation is affected by absorption and reflection from structures, objects and people.</p> |  |   |

## Warranty and After-Sale Service

The device is under warranty for one year from the date of purchase.

The batteries, the packaging, and any damage caused by improper use are not covered by the warranty.

Excluding the following user-caused failures:

- 1.Failure resulting from unauthorized disassembly and modification.
- 2.Failure resulting from an unexpected dropping during application or transportation.
- 3.Failure resulting from not following the instructions in the user's manual.

After-sale service unit: Shenzhen Jumper Medical Equipment Co., Ltd.

Address: D Building, No. 71, Xintian Road, Fuyong Street, Baoan, Shenzhen,Guangdong,China

Tel: +86-755-26696279

Fax: +86-755-26852025

E-mail: [info@jumper-medical.com](mailto:info@jumper-medical.com)

Website: [www.jumper-medical.com](http://www.jumper-medical.com)

Postal Code: 518103

### Authorized European Representative:



Wellkang Ltd

Suite B, 29 Harley Street, London W1G 9QR, UK

## Packungsinhalt

| No. | Name                 | Menge |
|-----|----------------------|-------|
| 1   | Infrarot Thermometer | 1     |
| 2   | Beutel               | 1     |
| 3   | Batterie (AAA)       | 2     |
| 4   | Bedienungsanleitung  | 1     |

## Körpertemperatur-Grundlagen

| Körperteil | Normaler Temperaturbereich       |
|------------|----------------------------------|
| Stirn      | 34.7°C-37.3°C / (94.5°F- 99.1°F) |
| Gehörgang  | 35.8°C-38.0°C / 96.4°F-100.4°F   |
| Mund       | 35.5°C-37.5°C / 95.9°F-99.5°F    |
| Achsel     | 34.7°C-37.3°C / 94.5°F-99.1°F    |
| Anus       | 36.6°C-38.0°C / 97.9°F-100.4°F   |

## Produktstruktur

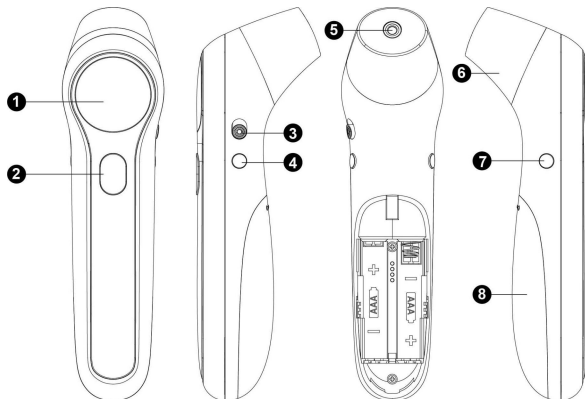

- (1) LCD-Bildschirm
- (2) Ein- / Ausschalter / Messtaster
- (3) Geräteschaltknopf (°C / °F)
- (4) Modustaste (Erwachsenenmodus / Kindermodus / Objekt)
- (5) Sonde (Abdeckung abnehmen, wenn die Ohrtemperatur gemessen wird)
- (6) Sondenabdeckung (Automatischer Wechsel zwischen Objekt-, Stirn- und Ohrmodus durch Entfernen der Sondenabdeckung zur Messung der Ohrtemperatur und Zurücksetzen der Sondenabdeckung zur Messung der Objekt- und Stirntemperatur.)
- (7) Memory-Taste / Sound-Schalter
- (8) Batterieabdeckung

## Beschreibung anzeigen

1. Objekttemperaturmodus
2. Adult Stirn Temperaturmodus
3. Kindermodus
4. Ohrtemperaturmodus

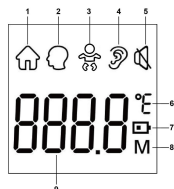

5. Stummschalten / Stummschalten aufheben
6. Temperatureinheit (°C /°F)
7. Batterie schwach
8. Speicherabruf
9. Temperaturwert



## Anweisungen für Töne und Hintergrundbeleuchtung

| Angebot                              | Geräusche          | Hintergrund-<br>beleuchtung |
|--------------------------------------|--------------------|-----------------------------|
| Stirntemperatur (Erwachsener / Kind) |                    |                             |
| 35.0°C-37.5°C/95.0°F -99.5°F         | Ein langer Piepton | grün                        |
| 37.6°C-42.2°C/99.6°F -108.0°F        | 3 kurze doppelte   | rot                         |
| Ohrtemperatur (Erwachsener / Kind)   |                    |                             |
| 35.0°C-37.5°C/95.0°F -99.5°F         | Ein langer Piepton | grün                        |
| 37.6°C-42.0°C/99.6°F -107.6°F        | 3 kurze doppelte   | rot                         |
| Objekttemperatur                     |                    |                             |
| 0°C-100°C/32.0°F -212°F              | Ein langer Piepton | grün                        |





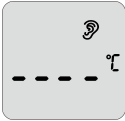

**Hinweis:** Wenn die Temperatur an Stirn und Ohr zwischen 35.0°C/95.0°F und 37.5°C/99.5°F liegt, ertönt ein langer Piepton und eine grüne Hintergrundbeleuchtung. Dies zeigt an, dass Ihre Körpertemperatur normal ist.

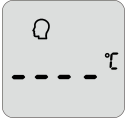

Wenn die Stirntemperatur zwischen 37.6°C/99.6°F und 42.2°C/108.0°F und die Ohrtemperatur zwischen 37.6°C/99.6°F und 42.0°C/107.6°F liegt, ertönen drei kurze doppelte Pieptöne und ein roter Ton Hintergrundbeleuchtung. Dies zeigt an, dass Ihre Körpertemperatur ein wenig hoch ist. Möglicherweise haben Sie Fieber. Bitte fragen Sie Ihren Arzt, wenn Sie sich nicht sicher sind.

## Anzeige- und Bedienungsanleitung

| Bildschirmanzeige   | Bedienungsanleitung<br>Angezeigter Status  | Ton und Hintergrundbeleuchtung   |
|---|--|--|
| Messung der Ohrtemperatur (Erwachsener / Kind)  |  |  |
|  <p style="text-align: center;">↓</p>  <p>Ohrtemperatur für Erwachsene</p>  <p>Ohrtemperatur für Kind</p> | <p>Nehmen Sie die Sondenabdeckung ab, halten Sie den Netzschalter 1 Sekunde lang gedrückt, um das Thermometer einzuschalten. Das Symbol "👂" wird auf dem Bildschirm angezeigt.</p> <p>Wechseln Sie in den Erwachsenen- oder Kindermessmodus, indem Sie den seitlichen Erwachsenen- / Kinderschalter entsprechend Ihren Messanforderungen wählen.</p> <p>Setzen Sie den Temperaturfühler an der richtigen Stelle im Gehörgang ein. Drücken Sie die Taste Measure, um eine Messung zu starten.</p> | <p>Siehe die Tabelle im Abschnitt „Anweisungen zu Ton und Hintergrundbeleuchtung“.</p> |
| Messung der Stirntemperatur (Erwachsener / Kind)  |  |  |



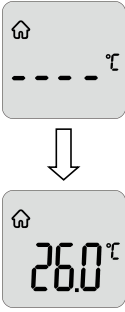

| Bildschirmanzei-<br>ge  | Bedienungsanleitung<br>Angezeigter Status  | Ton und<br>Hintergrundbeleuc-<br>htung   |
|---|--|--|
| <br><br><br>Stirntemperatur<br>für<br>Erwachsene<br><br>Stirntemperatur<br>für Kind | <p>Setzen Sie die Abdeckung auf die Sonde, drücken Sie die Ein- / Aus-Taste 1 Sekunde lang, um das Thermometer einzuschalten. Das Symbol "Kopf"  wird auf dem Bildschirm angezeigt.</p> <p>Wechseln Sie in den  Messmodus für Erwachsene oder Kinder, indem Sie den Seitenschalter für Erwachsene / Kinder entsprechend Ihren Messanforderungen wählen.</p> <p>Richten Sie das Thermometer auf die Mitte der Stirn. Halten Sie etwa 1 bis 3 cm Abstand von der Hautoberfläche. Drücken Sie kurz die Messtaste. Die Temperatur wird auf dem Bildschirm angezeigt.</p> | <p>Siehe die Tabelle im Abschnitt „Anweisungen zu Ton und Hintergrundbeleuchtung“.</p> |
| Objekttemperatur messen   |  |  |

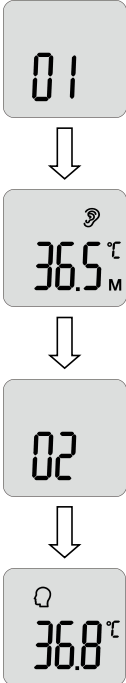

| Bildschirmanzeige   | Bedienungsanleitung<br>Angezeigter Status   | Ton und<br>Hintergrundbeleuchtung  |
|---|---|--|
|                            | <p>Setzen Sie die Abdeckung auf die Sonde und wechseln Sie durch Drücken der Modustaste in den Objektmessmodus. Das Thermometer wechselt in den Objektmodus. Das Symbol "Haus"  wird auf dem Bildschirm angezeigt.</p> <p>Richten Sie das Thermometer auf die Mitte des Objekts. Drücken Sie kurz die Messtaste. Die Temperatur wird auf dem Bildschirm angezeigt.</p> | <p>Siehe die Tabelle im Abschnitt „Anweisungen zu Ton und Hintergrundbeleuchtung“.</p> |
| <p>Außerhalb der Messbereichsanzeige</p>  |   |  |
|  <p>(nur als Referenz)</p> | <p>Im Ohrmodus wird eine Temperatur von mehr als 42.0°C (107.6°F) angezeigt.</p> <p>Im Stirnmodus wird eine Temperatur von mehr als 42.2°C (108.0°F) angezeigt.</p> <p>Im Objektmodus wird eine Temperatur von mehr als 100°C (212.0°F) angezeigt.</p>  | <p>Ein langer Piepton, die Hintergrundbeleuchtung ist rot.</p>                         |

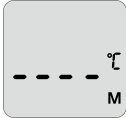
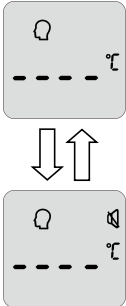
| Bildschirmanzeigen  | Bedienungsanleitung<br>Angezeigter Status  | Ton und<br>Hintergrundbeleuchtung                              |
|---|--|--|
|  <p>(nur als Referenz)</p> | <p>Im Ohrmodus wird eine Temperatur von weniger als 35.0°C (95.0°F) angezeigt.</p> <p>Im Stirnmodus wird eine Temperatur von weniger als 35.0°C (95.0°F) angezeigt.</p> <p>Im Objektmodus wird eine Temperatur von weniger als 0°C (32.0°F) angezeigt.</p> | <p>Ein langer Piepton, die Hintergrundbeleuchtung ist rot.</p> |
| Erinnere dich an 20 Erinnerungen  |  |  |

| Bildschirmanzeigen  | Bedienungsanleitung<br>Angezeigter Status  | Ton und Hintergrundbeleuchtung                      |
|---|--|---|
|  <p>The sequence shows four screen displays connected by downward arrows. The first display shows '01'. The second shows '36.5°C' with a small ear icon above the temperature. The third shows '02'. The fourth shows '36.8°C' with a small ear icon above the temperature.</p> | <p>Drücken Sie im eingeschalteten Zustand die Speichertaste, um den Speichermodus aufzurufen.</p> <p>Wenn die Speichertaste losgelassen wird, wird 01 angezeigt, gefolgt von der aufgezeichneten Messung.</p> <p>Drücken Sie die Speichertaste erneut, um die nächsten aufgezeichneten Daten abzurufen. 02 wird angezeigt, gefolgt von der aufgezeichneten Ablesung.</p> <p>Es können maximal 20 Temperaturmesswerte abgerufen werden.</p> <p>Wenn die maximale Anzahl von Datensätzen überschritten wird, werden die frühesten Speicherdaten überschrieben.</p> <p>Hinweis:<br/>01 bedeutet die neuesten Daten.</p> | <p>Lautlos ist die Hintergrundbeleuchtung grün.</p> |
| Keine Speicherdaten / Speicherdaten löschen   |  |   |

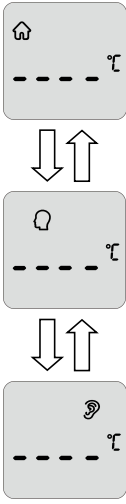
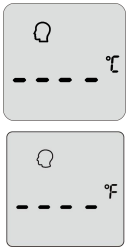
| Bildschirmanzeige  | Bedienungsanleitung<br>Angezeigter Status   | Ton und<br>Hintergrundbeleuchtung   |
|--|---|---|
|   | <p>Die Anzeige ist wie gezeigt, wenn beim Abrufen von Speichern keine Daten mehr überprüft werden.<br/>Entfernen Sie 2 Trockenbatterien und installieren Sie die Stromversorgung nach 10 Sekunden erneut, um alle Speicherdaten zu löschen.</p>   | <p>Wenn die Stromversorgung wieder eingeschaltet wird, ertönt ein langer Piepton und eine grüne Hintergrundbeleuchtung, die dann rot wird</p> |
| <p>Zwischen Stummschalten und Aufheben der Stummschaltung wechseln</p>             |   |   |
|  | <p>Halten Sie im eingeschalteten Zustand den Tonschalter etwa 2 Sekunden lang gedrückt, um den Ton ein- oder auszuschalten. Wenn der Ton eingeschaltet ist, ertönt ein Signalton und das Stummschaltungssymbol wird angezeigt, wenn der Ton ausgeschaltet ist.</p> <p>Das  Symbol wird im Mute-Modus angezeigt und verschwindet im Unmute-Modus.</p> | <p>Wenn der Ton eingeschaltet ist, ertönt ein langer Piepton und die Hintergrundbeleuchtung ist grün.</p>                                     |
| <p>Umschalten zwischen Objekttemperatur und Körpertemperatur</p>                   |   |   |

| Bildschirmanzei-<br>ge   | Bedienungsanleitung<br>Angezeigter Status   | Ton und<br>Hintergrundbele-<br>uchtung              |
|--|---|---|
|   | <p>Drücken Sie beim Aufsetzen der Sondenabdeckung die Modustaste, um zwischen Objekt- und Stirnmodus zu wechseln. Der Ohrmodus (Erwachsener / Kind) wird durch Entfernen der Sondenabdeckung aktiviert.</p> | <p>Lautlos ist die Hintergrundbeleuchtung grün.</p> |
| <p>Umschalten zwischen °F/°C</p>   |   |   |
|  | <p>Im eingeschalteten Zustand können Sie die Einheiten wechseln, indem Sie die Taste °F / °C umschalten.</p>  | <p>Leise</p>  |

| Bildschirmanzeige   | Bedienungsanleitung<br>Angezeigter Status   | Ton und<br>Hintergrundbeleuchtung                       |
|---|---|---|
| Fehlerinformation & Batterie schwach  |   |   |
|  | Die Umgebungstemperatur ist höher als 40.0°C (104.0°F) oder niedriger als 10.0°C (50.0°F).  | Ein langer Piepton, die Hintergrundbeleuchtung ist rot. |
|  | Ein Fehler tritt auf, wenn Daten aus dem Speicher gelesen oder in diesen geschrieben werden oder die Temperaturkorrektur nicht abgeschlossen ist.                     | Ein langer Piepton, die Hintergrundbeleuchtung ist rot. |
|  | Wenn die Batteriespannung unter $2.4\text{ V} \pm 0.1\text{ V}$ liegt, erscheint das Symbol für niedrigen Batteriestand im Display. Bitte ersetzen Sie die Batterien. | Leise   |

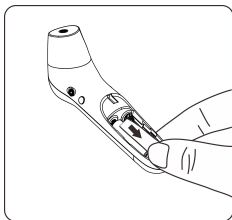
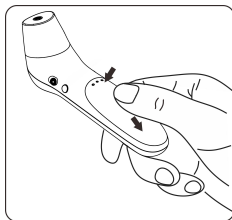

## Messung der Ohrtemperatur

1. Wenn Sie das Thermometer zum ersten Mal verwenden, entfernen Sie das Isolierstück der Batterie.

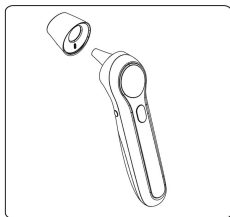

2. Nehmen Sie die Sondenabdeckung vom Thermometer ab, bevor Sie die Ohrtemperatur messen.



3. Drücken Sie die Ein- / Aus-Taste, um das Thermometer einzuschalten. Das Symbol "Ohr"  wird auf dem Bildschirm angezeigt.
4. Wechseln Sie durch Drücken der Modustaste zwischen den Modi "Erwachsener" und "Kind". Das Symbol  wird im untergeordneten Modus angezeigt.
5. Führen Sie den Temperaturfühler in den Gehörgang ein.
6. Drücken Sie kurz die Messtaste. Die gemessene Ohrtemperatur wird sofort auf dem Bildschirm angezeigt..

**Hinweis:** Kinder unter 1 Jahr: Ziehen Sie das Ohr gerade nach hinten.

Kinder von 1 Jahr bis zum Erwachsenen: Ziehen Sie das Ohr nach oben und hinten.

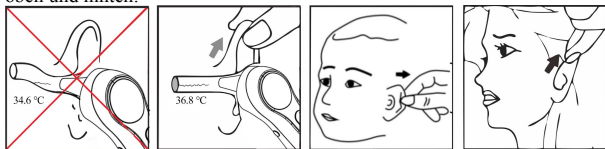

Drücken Sie das Thermometer nicht mit Gewalt in den Gehörgang.

Andernfalls kann der Gehörgang verletzt werden.







Wenn Sie die Temperatur bei einem Erwachsenen messen, ziehen Sie das Ohr vorsichtig nach oben und hinten, um sicherzustellen, dass der Gehörgang gerade ist, damit der Temperaturfühler einen Infrarotstrahl vom Trommelfell empfangen kann.



Seien Sie vorsichtig, wenn Sie die Temperatur eines Kindes messen, dessen Gehörgang klein ist.

## Messung der Stirntemperatur

1. Setzen Sie den Deckel auf die Sonde des Thermometers.
2. Drücken Sie die Ein- / Aus-Taste, um das Thermometer einzuschalten. Das Symbol  wird auf dem Bildschirm angezeigt.
3. Schalten Sie zwischen den Modi "Erwachsener" und "Kind" um, indem Sie die Modustaste drücken. Das Symbol  wird im untergeordneten Modus angezeigt.
4. Richten Sie die Thermometer-Sonde auf die Mitte der Stirn, etwa 1 bis 3 cm von der Hautoberfläche entfernt.

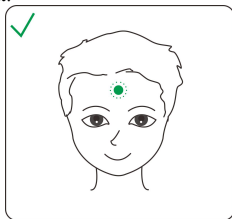
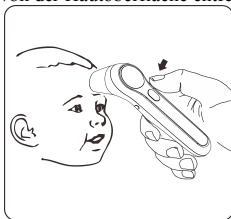

5. Drücken Sie die Messtaste und lassen Sie sie 1 Sekunde lang los. Der Temperaturwert wird sofort auf dem Bildschirm angezeigt.
6. Wird keine Aktivität festgestellt, schaltet sich das Thermometer nach 10 Sekunden automatisch aus.

## Objekttemperatur messen

1. Setzen Sie den Deckel auf die Sonde des Thermometers.
2. Drücken Sie den Ein- / Ausschalter, um das Thermometer einzuschalten.

3. Drücken Sie die Modustaste. Das Thermometer wechselt in den Objektmodus. Das Symbol “” wird auf dem Bildschirm angezeigt.
4. Richten Sie die Thermometer-Sonde auf die Mitte des Objekts, etwa 1 bis 3 cm von der Objektoberfläche entfernt.
5. Drücken Sie die Messtaste und lassen Sie sie 1 Sekunde lang los. Der Temperaturwert wird sofort auf dem Bildschirm angezeigt.
6. Wird keine Aktivität festgestellt, schaltet sich das Thermometer nach 10 Sekunden automatisch aus.

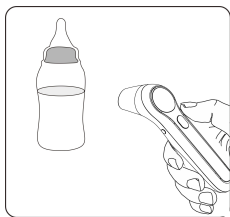

### Nach einer Messung

- (1) Nach jeder Messung können Sie in den Rückrufmodus wechseln und frühere Temperaturwerte abfragen. Weitere Informationen finden Sie unter "Abrufen von 20 Speichern" in der vorhergehenden Tabelle.
- (2) Reinigen Sie den Temperaturfühler nach jeder Messung mit einem weichen Tuch und stellen Sie das Thermometer an einen trockenen und gut belüfteten Ort.



Es ist gefährlich, anhand der erhaltenen Messergebnisse eine Eigendiagnose oder Selbstbehandlung durchzuführen. Wenden Sie sich hierzu bitte an einen Arzt.

### Fehlerbehebung

| Problem | Mögliche Ursache | Lösung |
|---------|------------------|--------|
|---------|------------------|--------|

|  |  |   |
|--|--|---|
| Das Thermometer lässt sich nicht einschalten.                            | Niedriger Batteriestatus   | Wechseln Sie die Batterien.   |
|  | Die Polaritäten der Batterien sind vertauscht.   | Stellen Sie sicher, dass die Batterien richtig eingelegt sind.                              |
|  | Das Thermometer ist beschädigt.  | Kontaktieren Sie den Hersteller.  |
| "Er1" wird angezeigt.  | Die Umgebungstemperatur liegt unter 10°C oder über 40°C.   | Nehmen Sie eine Messung bei einer Umgebungstemperatur zwischen 10°C und 40°C vor.           |
| Der Temperaturwert liegt unter dem typischen Körpertemperaturbereich.    | Die Linse des Temperaturfühlers ist verschmutzt.   | Reinigen Sie die Linse mit einem Wattestäbchen.   |
|  | Die Thermometersonde ist nicht am Trommelfell ausgerichtet.  | Positionieren Sie die Thermometersonde so, dass sie am Trommelfell ausgerichtet ist.        |
|  | Das Thermometer wird innerhalb von 30 Minuten nach der Entnahme aus einer kalten Umgebung verwendet. | Warten Sie mehr als 30 Minuten, nachdem das Thermometer in die Messumgebung gebracht wurde. |
| Der Temperaturmesswert liegt über dem typischen Körpertemperaturbereich. | Der Temperaturfühler ist beschädigt.   | Kontaktieren Sie den Hersteller.  |

## Spezifikationen

|                              |  |
|------------------------------|--|
| Produktname                  | Infrarot Thermometer   |
| Produktmodell                | JPD-FR300  |
| Netzteilmodus                | Interne Stromversorgung  |
| Betriebsspannung             | DC 3V  |
| Batteriemodell               | AAA x 2  |
| Betriebsart                  | Dauerbetrieb   |
| Anzeige                      | Segment LCD  |
| Messzeit                     | Ungefähr 1 Sekunde   |
| Latenzzeit                   | Ungefähr 3 Sekunden  |
| Messbereich                  | Stirnmodus: 35.0°C–42.2°C (95.0°F–108.0°F)<br>Ohrmodus: 35.0°C–42.0°C (95.0°F–107.6°F)<br>Objektmodus: 0.0°C–100.0°C (32.0°F–212.0°F)  |
| Genauigkeit<br>(Labor)       | Stirnmodus: $\pm 0.2^{\circ}\text{C}$ ( $\pm 0.4^{\circ}\text{F}$ )<br>Ohrmodus: $\pm 0.2^{\circ}\text{C}$ ( $\pm 0.4^{\circ}\text{F}$ )<br>Objektmodus: $\pm 1.0^{\circ}\text{C} / \pm 2.0^{\circ}\text{F}$ |
| Auflösung                    | 0.1°C (0.1°F)  |
| Erinnerung                   | 20 Temperaturanzeigen  |
| Alarm bei schwacher Batterie | Das Batteriesymbol wird angezeigt, wenn die Netzspannung unter 2.4 V $\pm$ 0.1 V liegt   |
| Automatisches Ausschalten    | Das Thermometer schaltet sich automatisch aus, wenn es innerhalb von 10 $\pm$ 1 Sekunden nicht benutzt wird.   |
| Außenmaße (mm)               | 155.9 * 40.2 * 49.2 mm   |
| Gewicht (g)                  | Thermometer (mit Batterien): 90 g  |
| Betriebsumgebung             | Temperatur: 10°C ~ 40°C  |
|                              | Luftfeuchtigkeit: 15% - 95% rF, nicht kondensierend  |
|                              | Atmosphärendruck: 86 - 106 kPa   |

## Contenu du colis

| No. | Nom                    | Quantité |
|-----|------------------------|----------|
| 1   | Thermomètre infrarouge | 1        |
| 2   | Poche                  | 1        |
| 3   | Batterie (AAA)         | 2        |
| 4   | Manuel d'instructions  | 1        |

## Bases de la température corporelle

| Partie du corps           | Plage de température normale   |
|---------------------------|--------------------------------|
| <b>Front</b>              | 34.7°C-37.3°C / 94.5°F- 99.1°F |
| <b>Le conduit auditif</b> | 35.8°C-38.0°C / 96.4°F-100.4°F |
| <b>Bouche</b>             | 35.5°C-37.5°C / 95.9°F-99.5°F  |
| <b>Aisselle</b>           | 34.7°C-37.3°C / 94.5°F-99.1°F  |
| <b>Anus</b>               | 36.6°C-38.0°C / 97.9°F-100.4°F |

## La structure du produit

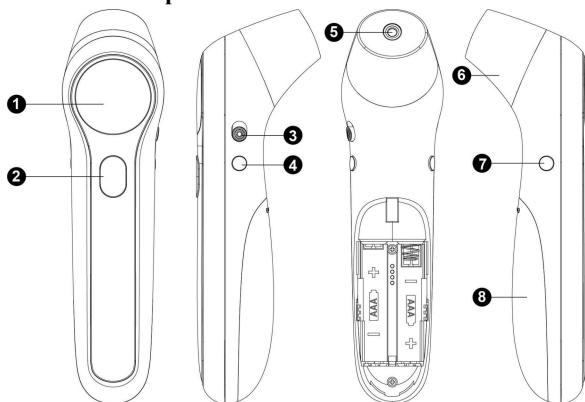

- (1) Écran d'affichage LCD
- (2) Bouton d'alimentation / bouton de mesure
- (3) Bouton de commutation de l'unité (°C / °F)
- (4) Bouton Mode (mode adulte / mode enfant / objet)
- (5) Sonde (enlever le couvercle lors de la mesure de la température de l'oreille)
- (6) Couvercle de sonde (Basculement automatique entre les modes objet, front et oreille, en retirant le couvercle de la sonde pour mesurer la température de l'oreille et en replaçant le couvercle de la sonde pour la mesure de la température de l'objet et du front.)
- (7) Bouton de mémoire / son commutateur
- (8) Couvercle de la batterie

## Afficher la description

1. Mode de température d'objet
2. Mode de température du front adulte
3. Mode enfant
4. Mode de température auriculaire
5. Muet / Non-Muet

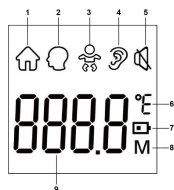



6. Unité de température (°C / °F)
7. Batterie faible
8. Rappel de mémoire
9. valeur de température

## Instructions de couleur des sons et du rétroéclairage



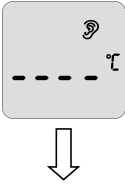

| Gamme                                      | Des sons              | Rétro-éclairage |
|--|-----------------------|-----------------|
| Température frontale (adulte / enfant)     |                       |                 |
| 35.0°C-37.5°C/95.0°F-99.5°F                | Un long bip           | vert            |
| 37.6°C-42.2°C/99.6°F-108.0°F               | 3 doubles bips courts | rouge           |
| Température de l'oreille (adulte / enfant) |                       |                 |
| 35.0°C-37.5°C/95.0°F-99.5°F                | Un long bip           | vert            |
| 37.6°C-42.0°C/99.6°F-107.6°F               | 3 doubles bips courts | rouge           |
| Température de l'objet                     |                       |                 |
| 0°C-100°C/32.0°F-212°F                     | Un long bip           | vert            |



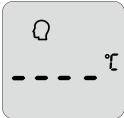

**Remarque:** Lorsque la température du front et des oreilles est comprise entre 35.0°C/95.0°F et 37.5°C/99.5°F, un bip long et un rétro-éclairage vert sont émis. Cela indique que la température de votre corps est normale. Lorsque la température du front se situe entre 37.6°C/99.6°F et 42.2°C/108.0°F et que la température de l'oreille est entre 37.6°C/99.6°F et 42.0°C/107.6°F, il y aura 3 doubles bips courts et un rouge rétro-éclairage. Cela indique que la température de votre corps est un peu élevée. Vous pouvez avoir de la fièvre. S'il vous plaît consulter votre médecin si vous n'êtes pas sûr.

## Affichage et mode d'emploi

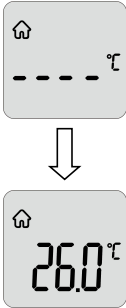

| Écran d'affichage  | Mode d'emploi<br>Etat affiché   | Couleur son et rétroéclairage   |
|--|---|---|
| Mesurer la température de l'oreille (adulte / enfant)  |   |   |
|  <p data-bbox="137 768 298 848">Température de l'oreille pour adulte</p>  <p data-bbox="137 1038 298 1118">Température de l'oreille pour l'enfant</p> | <p data-bbox="315 513 664 666">Retirez le couvercle de la sonde, appuyez et relâchez le bouton d'alimentation pendant 1 seconde pour allumer le thermomètre. Le symbole  s'affiche à l'écran.</p> <p data-bbox="315 688 692 797">Passez en mode de mesure adulte ou enfant en composant le sélecteur latéral adulte / enfant en fonction de vos besoins en matière de mesure.</p> <p data-bbox="315 818 671 958">Insérez la sonde de température dans une position appropriée dans le conduit auditif. Appuyez sur le bouton Mesurer pour lancer une mesure.</p> | <p data-bbox="705 666 886 812">Consulte la tabla en la sección "Instrucciones de color de luz de fondo y sonido".</p> |
| Mesure de la température frontale (adulte / enfant)  |   |   |

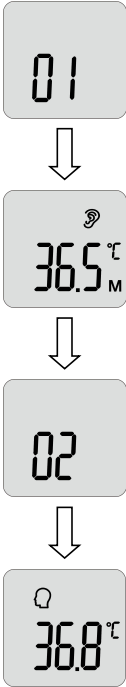

| Écran d'affichage   | Mode d'emploi<br>Etat affiché  | Couleur son et rétroéclairage   |
|---|--|---|
|  <p style="text-align: center;">↓</p>  <p>Température frontale pour adulte</p>  <p>Mesure de la température frontale (adulte / enfant)</p> | <p>Placez le couvercle sur la sonde, appuyez et relâchez le bouton d'alimentation pendant 1 seconde pour allumer le thermomètre. Le symbole "Tête"  s'affiche à l'écran.</p> <p>Passez en mode de mesure  adulte ou enfant en composant le sélecteur latéral adulte / enfant en fonction de vos besoins en matière de mesure.</p> <p>Dirigez le thermomètre vers le centre du front, à environ 1-3 cm de la surface de la peau. Appuyez et relâchez le bouton Mesurer. La température sera affichée à l'écran.</p> | <p>Reportez-vous au tableau de la section «Instructions concernant les couleurs du son et du rétroéclairage».</p> |
| Mesure de la température de l'objet   |  |   |

| Écran d'affichage   | Mode d'emploi<br>Etat affiché  | Couleur son et rétroéclairage   |
|---|--|---|
|                                      | <p>Placez le couvercle sur la sonde, passez en mode de mesure d'objet en appuyant sur le bouton Mode. Le thermomètre passe en mode objet. Le symbole "Maison"  s'affiche à l'écran.</p> <p>Pointez le thermomètre vers le centre de l'objet. Appuyez et relâchez le bouton Mesurer. La température sera affichée à l'écran.</p> | <p>Reportez-vous au tableau de la section «Instructions concernant les couleurs du son et du rétroéclairage».</p> |
| Affichage hors plage de mesure  |  |   |
|  <p>(pour référence seulement)</p>   | <p>En mode oreille, une température de plus de 42.0°C (107.6°F)</p> <p>En mode frontal, une température de plus de 42.2°C (108.0°F)</p> <p>En mode objet, une température de plus de 100°C (212.0°F)</p>   | <p>Un long bip, le rétro-éclairage est rouge.</p>   |
|  <p>(pour référence seulement)</p> | <p>En mode oreille, une température inférieure à 35.0°C (95.0°F)</p> <p>En mode Front, une température inférieure à 35.0°C (95.0°F)</p> <p>En mode objet, une température inférieure à 0°C (32.0°F)</p>  | <p>Un long bip, le rétro-éclairage est rouge.</p>   |
| Rappelez 20 mémoires  |  |   |

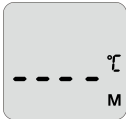
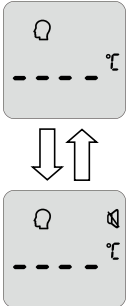
| Écran d'affichage  | Mode d'emploi<br>Etat affiché  | Couleur son et rétroéclairage                  |
|--|--|--|
|  | <p>À l'état allumé, appuyez sur le bouton Memory pour entrer en mode mémoire.</p> <p>Lorsque le bouton Memory est relâché, 01 s' affiche, suivi de la lecture enregistrée.</p> <p>Appuyez à nouveau sur le bouton Memory pour les prochaines données enregistrées. 02 sera affiché, suivi de la lecture enregistrée.</p> <p>Un maximum de 20 lectures de température peut être rappelé.</p> <p>Lorsque le nombre maximal d'enregistrements est dépassé, les premières données de la mémoire sont écrasées.</p> <p>Remarque:<br/>01 signifie les dernières données.</p> | <p>Silencieux, le rétroéclairage est vert.</p> |
| Pas de données en mémoire / Effacer les données en mémoire                         |  |  |

| Écran d'affichage   | Mode d'emploi<br>Etat affiché  | Couleur son et rétroéclairage   |
|---|--|---|
|  | <p>L'affichage est comme indiqué, lorsqu'il n'y a plus de données vérifiées lors du rappel des mémoires. Retirez 2 piles sèches et après 10 secondes, réinstallez l'alimentation pour effacer toutes les données de la mémoire.</p>  | <p>Lorsque l'alimentation est rétablie, il y a un long bip et un rétro-éclairage vert, qui devient ensuite rouge.</p> |
| <p>Basculer entre muet et non muet</p>  |  |   |
|  | <p>À l'état de mise sous tension, maintenez le bouton de commutation du son enfoncé pendant environ 2 secondes pour activer ou désactiver le son. Lorsque le son est activé, il émet un bip et le symbole de sourdine s'affiche lorsque le son est désactivé.</p> <p>Le symbole  est affiché en mode Mute et disparaît en mode Un-mute.</p> | <p>Lorsque le son est activé, un bip long retentit et le rétroéclairage est vert.</p>                                 |
| <p>Commutation entre la température de l'objet et la température du corps</p>     |  |   |

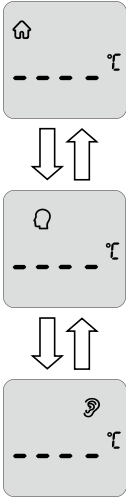
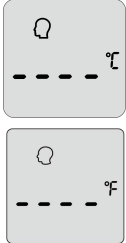
| Écran d'affichage  | Mode d'emploi<br>Etat affiché   | Couleur son et<br>rétroéclairage               |
|--|---|--|
|   | <p>Lors de la mise en place du couvre-sonde, appuyez sur le bouton Mode pour basculer entre les modes objet et front. Le mode d'oreille (adulte / enfant) sera activé en retirant le couvercle de la sonde.</p> | <p>Silencieux, le rétroéclairage est vert.</p> |
| <p>Commutation entre °F/°C</p>   |   |  |
|  | <p>À la mise sous tension, vous pouvez changer d'unité en appuyant sur le bouton °F / °C.</p>   | <p>Silencieux</p>                              |

| Écran d'affichage                        | Mode d'emploi<br>Etat affiché  | Couleur son et rétroéclairage              |
|--|--|--|
| Informations d'erreur et batterie faible |  |  |
|  | La température ambiante est supérieure à 40.0°C (104.0°F) ou inférieure à 10.0°C (50.0°F).   | Un long bip, le rétro-éclairage est rouge. |
|  | Une erreur se produit lorsque des données sont en cours de lecture ou d'écriture dans la mémoire ou que la correction de température n'est pas terminée. | Un long bip, le rétro-éclairage est rouge. |
|  | Lorsque la tension de la batterie est inférieure à 2.4V ± 0.1V, le symbole de batterie faible apparaît à l'écran. Veuillez remplacer les piles.          | Silencieux                                 |

## Mesurer la température d'oreille

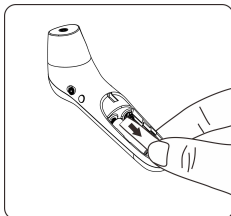
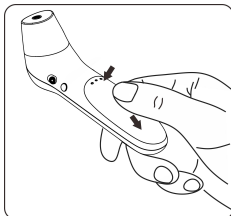

1. Lorsque vous utilisez le thermomètre pour la première fois, éloignez la pièce isolante de la batterie.

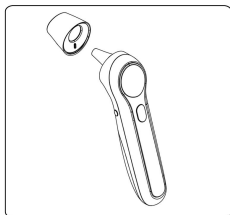

2. Retirez la protection de la sonde du thermomètre avant de mesurer la

température de l'oreille.



3. Appuyez sur le bouton Marche / Arrêt pour allumer le thermomètre. Le symbole "Oreille"  s'affiche à l'écran.
4. Basculez entre les modes "adulte" et "enfant" en appuyant sur le bouton Mode. le symbole  apparaît en mode "enfant".
5. Insérez la sonde de température dans le conduit auditif.
6. Appuyez et relâchez le bouton Mesurer. La température de l'oreille sera affichée à l'écran instantanément.

**Remarque:**

Enfants de moins de 1 an: tirez l'oreille vers l'arrière.

Enfants âgés d'un an à l'âge adulte: tirez l'oreille vers le haut et le dos.

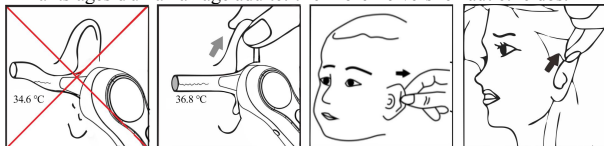

Ne forcez pas le thermomètre dans le conduit auditif. Sinon, le conduit auditif peut être blessé.





Lorsque vous prenez la température chez un adulte, tirez doucement l'oreille vers le haut et l'arrière pour vous assurer que le conduit

auditif est droit, afin que la sonde de température puisse recevoir un rayon infrarouge du tympan.



Faites attention lorsque vous prenez la température chez un enfant dont le conduit auditif est petit..

## Mesurer la température frontale

1. Placez le couvercle sur la sonde du thermomètre.
2. Appuyez sur le bouton d'alimentation pour allumer le thermomètre. le symbole “” est affiché à l'écran.
3. Basculez entre les modes “adulte” et “enfant” en appuyant sur le bouton Mode. le symbole  apparaît en mode “enfant”.
4. Dirigez la sonde du thermomètre vers le centre du front, à environ “1-3 cm “ de la surface de la peau.

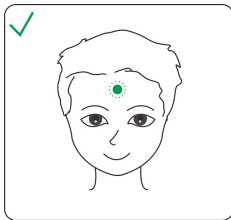
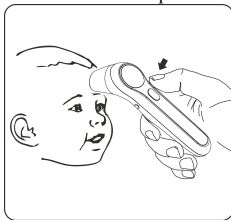

5. Appuyez et relâchez le bouton Mesurer pendant 1 seconde. La lecture de la température sera affichée à l'écran instantanément.
6. Si aucune activité n'est détectée, le thermomètre s'éteindra automatiquement au bout de 10 secondes..

## Mesure de la température de l'objet

1. Placez le couvercle sur la sonde du thermomètre.
2. Appuyez sur le bouton d'alimentation pour allumer le thermomètre.
3. Appuyez sur le bouton Mode, le thermomètre entre en mode objet. Le symbole “” est affiché à l'écran.
4. Pointez la sonde du thermomètre vers le centre de l'objet, à environ “1-3 cm “ de la surface de l'objet.
5. Appuyez et relâchez le bouton Mesurer pendant 1 seconde. La lecture



de la température sera affichée à l'écran instantanément.

6. Si aucune activité n'est détectée, le thermomètre s'éteindra automatiquement au bout de 10 secondes.

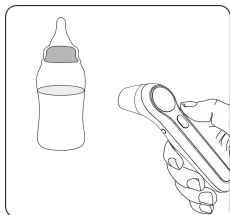

### Après une mesure

- (1) Après chaque mesure, vous pouvez passer en mode de rappel et interroger les relevés de température antérieurs. Pour plus de détails, voir "Rappeler 20 mémoires" dans le tableau précédent.
- (2) Après chaque mesure, nettoyez la sonde de température avec un chiffon doux et placez le thermomètre dans un endroit sec et bien ventilé.



Il est dangereux de faire un autodiagnostic ou un auto-traitement en fonction des résultats de mesure obtenus. Pour de telles fins, s'il vous plaît consulter un médecin.

### Dépannage

| Problème                        | Cause possible          | Solution                        |
|---------------------------------|-------------------------|---------------------------------|
| Le thermomètre ne s'allume pas. | Batterie faible         | Changer les piles.              |
|                                 | Les polarités des piles | Assurez-vous que les piles sont |

|   |   |   |
|---|---|---|
|   | sont inversées.   | correctement installées.  |
|   | Le thermomètre est endommagé.   | Contactez le fabricant.   |
| "Er1" est affiché.  | La température ambiante est inférieure à 10 °C (50.0 °F) ou supérieure à 40 °C (104 °F).                | Prenez une mesure à une température ambiante comprise entre 10 °C (40 °C) et 40 °C (104 °F).  |
| La lecture de la température est inférieure à la plage de température corporelle typique. | La lentille de la sonde de température est sale.  | Nettoyez la lentille avec un coton-tige.  |
|   | La sonde thermométrique n'est pas alignée sur le tympan.  | Repositionnez la sonde thermométrique de sorte qu'elle soit alignée avec le tympan.           |
|   | Le thermomètre est utilisé dans les 30 minutes qui suivent son prélèvement dans un environnement froid. | Attendez plus de 30 minutes après le transfert du thermomètre dans l'environnement de mesure. |
| La lecture de la température est supérieure à la plage de température corporelle typique. | La sonde de température est endommagée.   | Contactez le fabricant.   |

## Caractéristiques

|                |                        |
|----------------|------------------------|
| Nom du produit | Thermomètre infrarouge |
|----------------|------------------------|

|                               |   |
|-------------------------------|---|
| modèle du produit             | JPD-FR300   |
| Mode d'alimentation           | Alimentation interne  |
| Tension de fonctionnement     | DC 3V   |
| Modèle de batterie            | AAA x 2   |
| Mode de fonctionnement        | Fonctionnement continu  |
| Afficher                      | Segment LCD   |
| Mesurer le temps              | Environ 1 seconde   |
| Temps de latence              | Environ 3 secondes  |
| Plage de mesure               | Mode front:35.0°C–42.2°C (95.0°F–108.0°F)<br>Mode auriculaire:35.0°C–42.0°C (95.0°F–107.6°F)<br>Mode d'objet:0.0°C–100.0°C (32.0°F–212.0°F)   |
| Précision (laboratoire)       | Mode front: $\pm 0.2^{\circ}\text{C}$ ( $\pm 0.4^{\circ}\text{F}$ )<br>Mode auriculaire: $\pm 0.2^{\circ}\text{C}$ ( $\pm 0.4^{\circ}\text{F}$ )<br>Mode d'objet: $\pm 1.0^{\circ}\text{C}/\pm 2.0^{\circ}\text{F}$ |
| Résolution                    | 0.1°C (0.1°F)   |
| Mémoire                       | 20 lectures de température  |
| Alerte de pile faible         | Le symbole de pile faible s' affiche si la tension d' alimentation est inférieure à 2.4 V $\pm$ 0.1 V   |
| Mise hors tension automatique | Le thermomètre s'éteint automatiquement s'il n'est pas utilisé dans 10 $\pm$ 1 secondes.  |
| Dimensions extérieures (mm)   | 155.9 * 40.2 * 49.2 mm  |
| Poids (g)                     | Thermomètre (avec piles): 90g   |
| Environnement d'exploitation  | Température: 10 °C à 40 °C (50 °F à 104 °F)   |
|                               | Humidité: 15% à 95% d'humidité relative, sans condensation  |
|                               | Pression atmosphérique: 86 - 106 kPa  |

## Contenuto della confezione

| No. | Nome                    | Quantità |
|-----|-------------------------|----------|
| 1   | Termometro a infrarossi | 1        |
| 2   | Marsupio                | 1        |
| 3   | Batteria (AAA)          | 2        |
| 4   | Manuale di istruzioni   | 1        |

## Nozioni di base sulla temperatura corporea

| Parte del corpo | Intervallo di temperatura normale |
|-----------------|-----------------------------------|
| Fronte          | 34.7°C–37.3°C / 94.5°F–99.1°F     |
| Canale uditivo  | 35.8°C–38.0°C / 96.4°F–100.4°F    |
| Bocca           | 35.5°C–37.5°C / 95.9°F–99.5°F     |
| Ascella         | 34.7°C–37.3°C / 94.5°F–99.1°F     |
| Ano             | 36.6°C–38.0°C / 97.9°F–100.4°F    |

## Struttura del prodotto

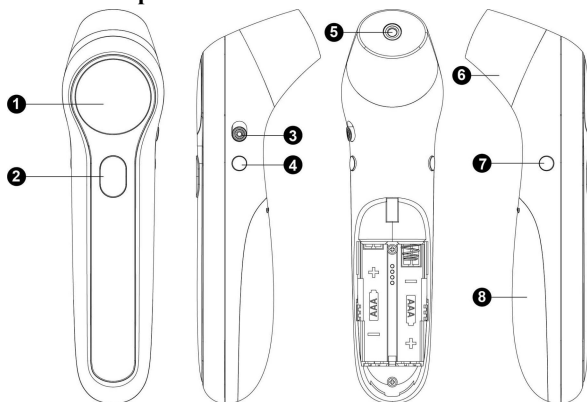

- (1) Schermo LCD
- (2) Pulsante di accensione / pulsante Misura
- (3) Pulsante di commutazione unità ( $^{\circ}\text{C}$  /  $^{\circ}\text{F}$ )
- (4) Pulsante modalità (Modalità adulto / Modalità bambino / Oggetto)
- (5) Sonda (togliere il coperchio quando si misura la temperatura dell'orecchio)
- (6) Coperchio della sonda (Commutazione automatica tra le modalità oggetto, fronte e orecchio, rimuovendo il coperchio della sonda per misurare la temperatura dell'orecchio e riposizionando il coperchio della sonda per la misurazione della temperatura dell'oggetto e della fronte.)
- (7) Pulsante di memoria / interruttore audio
- (8) Coperchio della batteria

## Visualizza descrizione

1. Modalità temperatura oggetto
2. Modalità temperatura fronte adulti
3. Modalità figlio
4. Modalità temperatura orecchio
5. Disattiva / riattiva l'audio

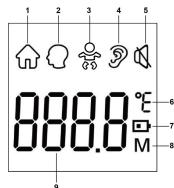

6. Unità di temperatura (°C /°F)
7. Batteria scarica
8. Richiamo della memoria
9. Temperatura



## Suoni e istruzioni sul colore della retroilluminazione





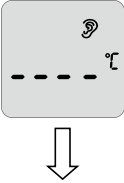

| Gamma  | Suoni            | Controluce |
|--|------------------|------------|
| Temperatura frontale (adulto / bambino)      |                  |            |
| 35.0°C-37.5°C/95.0°F -99.5°F                 | Un lungo segnale | verde      |
| 37.6°C-42.2°C/99.6°F -108.0°F                | 3 brevi segnali  | rosso      |
| Temperatura dell'orecchio (adulto / bambino) |                  |            |
| 35.0°C-37.5°C/95.0°F -99.5°F                 | Un lungo segnale | verde      |
| 37.6°C-42.0°C/99.6°F -107.6°F                | 3 brevi segnali  | rosso      |
| Temperatura dell'oggetto                     |                  |            |
| 0°C-100°C/32.0°F -212°F                      | Un lungo segnale | verde      |

**Nota:** Quando la temperatura della fronte e dell'orecchio è compresa tra 35.0°C/95.0°F e 37.5°C/99.5°F, si udirà un lungo segnale acustico e una retroilluminazione verde. Questo indica che la temperatura corporea è normale.

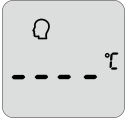

Quando la temperatura della fronte è compresa tra 37.6°C/99.6°F e 42.2°C/108.0°F e la temperatura dell'orecchio è compresa tra 37.6°C/99.6°F e 42.0°C/107.6°F, verranno emessi 3 segnali acustici doppi brevi e un rosso controluce. Questo indica che la temperatura corporea è un po' alta. Potresti avere la febbre. Si prega di consultare il proprio medico se non si è sicuri.

## Display e istruzioni per l'uso

| Schermo   | Istruzioni per l'uso<br>Stato visualizzato  | Colore audio e<br>retroilluminazione  |
|---|---|---|
| Misurazione della temperatura dell'orecchio (adulto / bambino)  |   |   |
|  <p data-bbox="130 783 306 870">Temperatura dell'orecchio per adulto</p>  <p data-bbox="130 1052 306 1140">Temperatura dell'orecchio per bambino</p> | <p data-bbox="313 513 692 703">Rimuovere il coperchio della sonda, premere e rilasciare il pulsante di accensione per 1 secondo per accendere il termometro. Il simbolo “” viene visualizzato sullo schermo.</p> <p data-bbox="313 717 676 863">Passa alla modalità di misurazione adulto o bambino componendo il selettore laterale adulto / bambino in base alle tue esigenze di misurazione.</p> <p data-bbox="313 877 686 994">Inserire la sonda di temperatura in una posizione corretta nel condotto uditivo. Premere il pulsante Misura per iniziare una misurazione.</p> | <p data-bbox="703 652 899 856">Vedere la tabella nella sezione "Istruzioni sul colore dell'audio e della retroilluminazione".</p> |
| Misurazione della temperatura frontale (adulto / bambino)   |   |   |

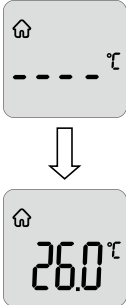

| Schermo   | Istruzioni per l'uso<br>Stato visualizzato  | Colore audio e<br>retroilluminazione  |
|---|---|---|
| <br><br> <p>Temperatura frontale per adulti</p><br> <p>Temperatura frontale per bambino</p> | <p>Posizionare il coperchio sulla sonda, premere e rilasciare il pulsante di accensione per 1 secondo per accendere il termometro. Il simbolo "Testa"  viene visualizzato sullo schermo.</p> <p>Passa alla modalità di misurazione  per adulti o bambini componendo il selettore laterale adulto / bambino in base alle tue esigenze di misurazione.</p> <p>Punta il termometro verso il centro della fronte. Di circa "1-3 cm" dalla superficie della pelle. Premere e rilasciare il pulsante Misura. La temperatura verrà visualizzata sullo schermo.</p> | <p>Vedere la tabella nella sezione "Istruzioni sul colore dell'audio e della retroilluminazione".</p> |
| Misurazione della temperatura dell'oggetto  |   |   |

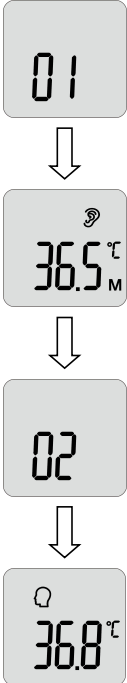

| Schermo  | Istruzioni per l'uso<br>Stato visualizzato   | Colore audio e<br>retroilluminazione  |
|--|--|---|
|                                 | <p>Posizionare il coperchio sulla sonda, passare alla modalità di misurazione oggetto premendo il pulsante Modalità. Il termometro passa alla modalità Oggetto. Il simbolo “Casa”  viene visualizzato sullo schermo.</p> <p>Puntare il termometro al centro dell'oggetto. Premere e rilasciare il pulsante Misura. La temperatura verrà visualizzata sullo schermo.</p> | <p>Vedere la tabella nella sezione "Istruzioni sul colore dell'audio e della retroilluminazione".</p> |
| Visualizzazione fuori dal campo di misura  |  |   |
|  <p>(solo come riferimento)</p> | <p>In modalità Orecchio, una lettura della temperatura superiore a 42.0° C (107.6°F)</p> <p>In modalità Fronte, una lettura della temperatura superiore a 42.2°C (108.0°F)</p> <p>In modalità Oggetto, una lettura della temperatura di oltre 100 °C (212.0 ° F)</p>   | <p>Un lungo segnale acustico, la retroilluminazione è rossa.</p>                                      |

| Schermo  | Istruzioni per l'uso<br>Stato visualizzato  | Colore audio e<br>retroilluminazione                             |
|--|---|--|
|  <p>(solo come riferimento)</p> | <p>In modalità Orecchio, una lettura della temperatura inferiore a 35.0°C (95.0°F)</p> <p>In modalità Fronte, una lettura della temperatura inferiore a 35.0°C (95.0°F)</p> <p>Nella modalità Oggetto, una lettura della temperatura inferiore a 0°C (32.0°F)</p> | <p>Un lungo segnale acustico, la retroilluminazione è rossa.</p> |
| Richiama 20 memorie  |   |  |

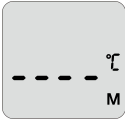
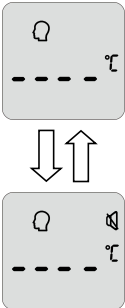
| Schermo   | Istruzioni per l'uso<br>Stato visualizzato  | Colore audio e<br>retroilluminazione              |
|---|---|---|
|  <p>The sequence shows four screen states: 1. '01' in a grey box. 2. '36.5°C' with an ear icon and 'M' in a grey box. 3. '02' in a grey box. 4. '36.8°C' with an ear icon in a grey box. White downward arrows connect each screen to the next.</p> | <p>In uno stato di accensione, premere il pulsante Memoria per accedere alla modalità memoria.</p> <p>Quando il pulsante Memory viene rilasciato, verrà visualizzato 01, seguito dalla lettura registrata.</p> <p>Premere di nuovo il pulsante Memory per i dati registrati successivi. Verrà visualizzato 02, seguito dalla lettura registrata.</p> <p>È possibile richiamare un massimo di 20 letture della temperatura.</p> <p>Quando viene superato il numero massimo di record, le prime registrazioni in memoria verranno sovrascritte</p> <p>Nota:<br/>01 indica i dati più recenti.</p> | <p>Silenzioso, la retroilluminazione è verde.</p> |
| Nessun dato di memoria / Cancella dati di memoria   |   |   |

| Schermo   | Istruzioni per l'uso<br>Stato visualizzato  | Colore audio e<br>retroilluminazione  |
|---|---|---|
|  | <p>Il display è come mostrato, quando non sono presenti più rilevazioni durante il richiamo delle memorie. Rimuovere le batterie, attendere 10 secondi e inserirle nuovamente per cancellare tutti i dati della memoria.</p>  | <p>Quando si riaccende, viene emesso un segnale acustico lungo con retroilluminazione da verde a rosso.</p> |
| Passa da muto a muto  |   |   |
|  | <p>Nello stato di accensione, tenere premuto il pulsante di commutazione audio per circa 2 secondi per attivare o disattivare l'audio. Quando il suono è attivato, verrà emesso un segnale acustico una volta e il simbolo di silenziamento verrà visualizzato quando il suono è disattivato.</p> <p>Il simbolo  viene visualizzato in modalità Mute e scompare in modalità Un-mute.</p> | <p>Quando il suono è attivato, viene emesso un lungo segnale acustico e la retroilluminazione è verde.</p>  |
| Commutazione tra temperatura dell'oggetto e temperatura corporea                  |   |   |

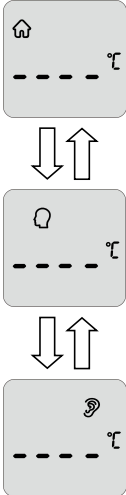
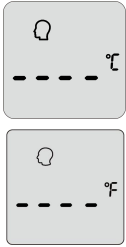
| Schermo  | Istruzioni per l'uso<br>Stato visualizzato   | Colore audio e<br>retroilluminazione<br>e         |
|--|--|---|
|   | <p>Dopo aver posizionato il coprisonda premere il pulsante Modalità per cambiare la modalità oggetto e fronte. La modalità orecchio (adulto / bambino) verrà attivata rimuovendo il coperchio della sonda.</p> | <p>Silenzioso, la retroilluminazione è verde.</p> |
| Commutazione tra °F/°C   |  |   |
|  | <p>In stato di accensione, è possibile modificare la misurazione con il pulsante °F / °C.</p>  | <p>Silenzioso</p>                                 |

| Schermo                                     | Istruzioni per l'uso<br>Stato visualizzato  | Colore audio e<br>retroilluminazione                      |
|---|---|---|
| Informazioni sull'errore e batteria scarica |   |   |
|   | La temperatura ambiente è superiore a 40.0°C (104.0°F) o inferiore a 10.0°C (50.0°F).   | Un lungo segnale acustico, la retroilluminazione è rossa. |
|   | Si verifica un errore quando i dati vengono letti o scritti nella memoria o la correzione della temperatura non è completa.                               | Un lungo segnale acustico, la retroilluminazione è rossa. |
|   | Quando la tensione della batteria è inferiore a 2.4 V $\pm$ 0.1 V, sul display appare il simbolo di batteria scarica. Si prega di sostituire le batterie. | Silenzioso  |

## Misurazione della temperatura dell'orecchio

- Quando si utilizza il termometro per la prima volta, spostare il pezzo isolante della batteria.

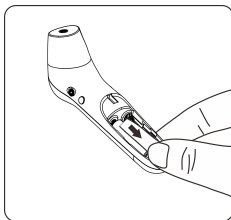
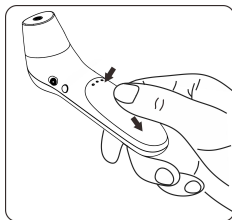

2. Rimuovere il coperchio della sonda dal termometro prima di misurare la temperatura dell'orecchio.

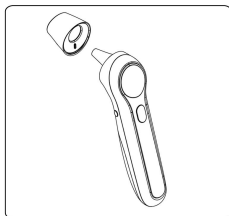

3. Premere il pulsante di accensione per accendere il termometro. Il simbolo “Orecchio”  viene visualizzato sullo schermo.
4. Per passare dalla modalita “adulto” a "bambino" premere il pulsante Modalità.
5. Inserire la sonda di temperatura nel condotto uditivo.
6. Premere e rilasciare il pulsante Misura. La lettura della temperatura dell'orecchio verrà immediatamente visualizzata sullo schermo.

**Nota:** Bambini di età inferiore a 1 anno: tirare indietro l'orecchio.

Bambini di età compresa tra 1 anno e adulto: tirare l'orecchio su e indietro.

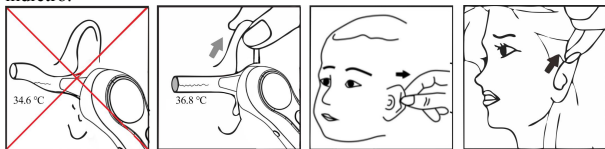

Non forzare il termometro nel condotto uditivo. Altrimenti, il canale uditivo potrebbe ferirsi.





Quando si misura la temperatura su un adulto, tirare delicatamente l'orecchio su e indietro per assicurarsi che il condotto uditivo sia

diritto, in modo che la sonda di temperatura possa ricevere un raggio infrarosso dal timpano.



Fare attenzione quando si prende la temperatura su un bambino, il cui condotto uditivo è piccolo..

## Misurazione della temperatura frontale

1. Mettere il coperchio sulla sonda del termometro.
2. Premere il pulsante di accensione per accendere il termometro. il simbolo “” viene visualizzato sullo schermo.
3. Per passare dalla modalità “adulto” a “bambino” premere il pulsante Modalità. Il simbolo  appare in modalità “bambino”.
4. Puntare la sonda del termometro verso il centro della fronte, a circa 1-3 cm dalla superficie della pelle.

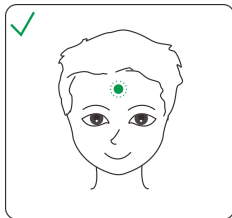
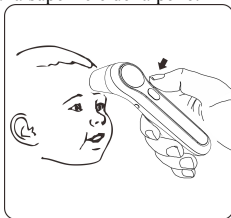

5. Premere e rilasciare il pulsante Misura per 1 secondo. La lettura della temperatura verrà immediatamente visualizzata sullo schermo.
6. Se non viene rilevata alcuna attività, il termometro si spegnerà automaticamente entro 10 secondi.

## Misurazione della temperatura dell'oggetto

1. Mettere il coperchio sulla sonda del termometro.
2. Premere il pulsante di accensione per accendere il termometro.
3. Premere il pulsante Modalità, il termometro entra nella modalità Oggetto. Il simbolo “” viene visualizzato sullo schermo.
4. Puntare la sonda del termometro verso il centro dell'oggetto, a circa “1-3 cm” dalla superficie dell'oggetto.
5. Premere e rilasciare il pulsante Misura per 1 secondo. La lettura della



temperatura verrà immediatamente visualizzata sullo schermo.

6. Se non viene rilevata alcuna attività, il termometro si spegnerà automaticamente entro 10 secondi.

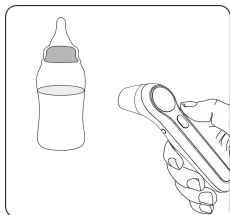

### Dopo una misurazione

- (1) Dopo ogni misurazione, è possibile accedere alla modalità di richiamo e interrogare letture di temperatura precedenti. Per maggiori dettagli, vedere "Richiama 20 memorie" nella tabella precedente.
- (2) Dopo ogni misurazione, pulire la sonda di temperatura con un panno morbido e posizionare il termometro in un luogo asciutto e ben ventilato.



È pericoloso effettuare un'autodiagnosi o un auto-trattamento in base ai risultati della misurazione ottenuti. Per tali scopi, consultare un medico.

### Risoluzione dei problemi

| Problema                      | Causa possibile                            | Soluzione                                    |
|-------------------------------|--|--|
| Il termometro non si accende. | Batteria scarica                           | Cambia le batterie.                          |
|                               | Le polarità delle batterie sono invertite. | Assicurarsi che le batterie siano installate |

|   |   |  |
|---|---|--|
|   |   | correttamente.   |
|   | Il termometro è danneggiato.  | Contattare il produttore   |
| Viene visualizzato "Er1".   | La temperatura ambiente è inferiore a 10 °C (50,0 ° F) o superiore a 40 °C (104 ° F).             | Effettuare una misurazione a una temperatura ambiente compresa tra 10 °C (50,0 ° F) e 40 °C (104 ° F). |
| La lettura della temperatura è inferiore all'intervallo di temperatura corporea tipica. | L'obiettivo della sonda di temperatura è sporco.  | Pulire l'obiettivo con un batuffolo di cotone.   |
|   | La sonda del termometro non è allineata al timpano.   | Riposizionare la sonda del termometro in modo che sia allineata al timpano.                            |
|   | Il termometro viene utilizzato entro 30 minuti dopo essere stato prelevato da un ambiente freddo. | Attendere più di 30 minuti dopo che il termometro è stato spostato nell'ambiente di misurazione.       |
| La lettura della temperatura è superiore all'intervallo di temperatura corporea tipica. | La sonda di temperatura è danneggiata.  | Contattare il produttore   |

## Specificazioni

|                   |                         |
|-------------------|-------------------------|
| Nome del prodotto | Termometro a infrarossi |
|-------------------|-------------------------|

|                            |   |
|----------------------------|---|
| Modello di prodotto        | JPD-FR300   |
| Modalità di alimentazione  | Alimentatore interno  |
| Tensione operativa         | DC 3V   |
| Modello di batteria        | AAA x 2   |
| Modalità operativa         | Funzionamento continuo  |
| Display                    | LCD a segmenti  |
| Misura il tempo            | 1 secondo circa   |
| Tempo di latenza           | 3 secondi circa   |
| Campo di misura            | Modalità fronte: 35.0°C–42.2°C (95.0°F–108.0°F)<br>Modalità orecchio: 35.0°C–42.0°C (95.0°F–107.6°F)<br>Modalità oggetto: 0.0°C–100.0°C (32.0°F–212.0°F)  |
| Precisione (Laboratorio)   | Modalità fronte: $\pm 0.2^{\circ}\text{C}$ ( $\pm 0.4^{\circ}\text{F}$ )<br>Modalità orecchio: $\pm 0.2^{\circ}\text{C}$ ( $\pm 0.4^{\circ}\text{F}$ )<br>Modalità oggetto: $\pm 1.0^{\circ}\text{C} / \pm 2.0^{\circ}\text{F}$ |
| Risoluzione                | 0.1°C (0.1°F)   |
| Memoria                    | 20 letture della temperatura  |
| Avviso di batteria scarica | Il simbolo di batteria scarica viene visualizzato se la tensione di alimentazione è inferiore a 2.4 V $\pm$ 0.1 V.  |
| Spegnimento automatico     | Il termometro si spegne automaticamente se non viene utilizzato in 10 $\pm$ 1 secondi.  |
| Dimensioni esterne (mm)    | 155.9 * 40.2 * 49,2 millimetri  |
| Peso (g)                   | Termometro (con batterie): 90g  |
| Ambiente operativo         | Temperatura: 10°C ~ 40°C (50°F - 104°F)   |
|                            | Umidità: 15% - 95% RH, senza condensa   |
|                            | Pressione atmosferica: 86 - 106 kPa   |

## Contenidos del paquete

| No. | Nombre                  | Cantidad |
|-----|-------------------------|----------|
| 1   | Termómetro infrarrojo   | 1        |
| 2   | Bolsa                   | 1        |
| 3   | Batería (AAA)           | 2        |
| 4   | Manual de instrucciones | 1        |

## Conceptos básicos de temperatura corporal

| Parte del cuerpo | Rango de temperatura normal    |
|------------------|--------------------------------|
| Frente           | 34.7°C-37.3°C / 94.5°F- 99.1°F |
| Canal auditivo   | 35.8°C-38.0°C / 96.4°F-100.4°F |
| Boca             | 35.5°C-37.5°C / 95.9°F-99.5°F  |
| Axila            | 34.7°C-37.3°C / 94.5°F-99.1°F  |
| Ano              | 36.6°C-38.0°C / 97.9°F-100.4°F |

## Estructura del producto

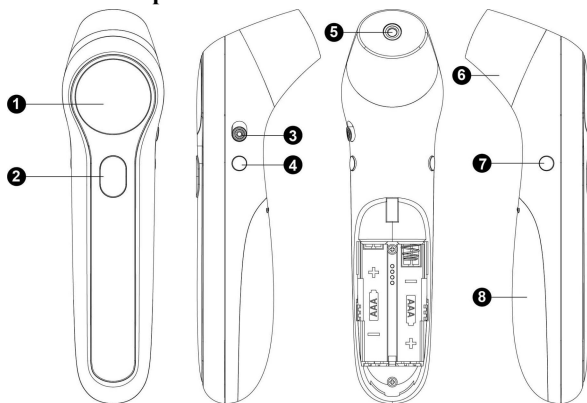

- (1) Pantalla LCD
- (2) Botón de encendido / botón de medición
- (3) Botón de selección (°C / °F)
- (4) Botón de modo (modo adulto / modo niño / objeto)
- (5) Sonda (retire la cubierta cuando mida la temperatura del oído)
- (6) Tapa de la sonda (Cambio automático entre los modos de objeto, frente y oído, quitando la cubierta de la sonda para medir la temperatura del oído y colocando nuevamente la cubierta de la sonda para medir la temperatura del objeto y la frente.)
- (7) Botón de memoria / interruptor de sonido
- (8) Tapa de la batería

## Descripción de la pantalla

1. Modo de temperatura del objeto
2. Modo de temperatura de la frente adulta
3. Modo infantil
4. Modo de temperatura del oído
5. Silencio / no silencio
6. Unidad de temperatura (°C / °F)

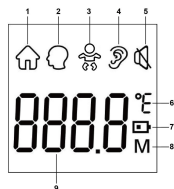

7. Batería baja
8. Recuperación de memoria
9. valor de temperatura

### Instrucciones de sonido y color de la luz





| Rango                                    | Sonido           | Color de la Luz |
|--|------------------|-----------------|
| Temperatura de la frente (adulto / niño) |                  |                 |
| 35.0°C-37.5°C/95.0°F -99.5°F             | Un pitido largo  | verde           |
| 37.6°C-42.2°C/99.6°F -108.0°F            | 3 pitidos dobles | rojo            |
| Temperatura del oído (adulto / niño)     |                  |                 |
| 35.0°C-37.5°C/95.0°F -99.5°F             | Un pitido largo  | verde           |
| 37.6°C-42.0°C/99.6°F -107.6°F            | 3 pitidos dobles | rojo            |
| Temperatura del objeto                   |                  |                 |
| 0°C-100°C/32.0°F -212°F                  | Un pitido largo  | verde           |

**Nota:** Cuando la temperatura de la frente y el oído está entre 35.0°C/95.0°F y 37.5°C/99.5°F, habrá un pitido largo y un color de la luz verde. Esto indica que la temperatura de su cuerpo es normal.

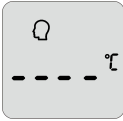

Cuando la temperatura de la frente esté entre 37.6°C/99.6°F y 42.2°C/108.0°F, y la temperatura del oído esté entre 37.6°C/99.6°F y 42.0°C/107.6°F, habrá 3 pitidos dobles cortos y un color de la luz rojo . Esto indica que la temperatura de tu cuerpo es un poco alta. Puede tener fiebre. Consulte a su médico si no está seguro.

## Pantalla e Instrucciones de Funcionamiento



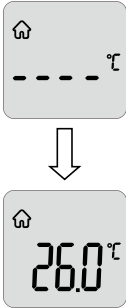

| Visualización de la pantalla  | Instrucciones de uso<br>Estado visualizado  | Sonido y Color de la Luz  |
|---|---|---|
| Medición de la temperatura del oído (adulto / niño)   |   |   |
|  <p data-bbox="132 768 304 827">Temperatura del oído para adulto</p> <p data-bbox="132 1006 304 1064">Temperatura del oído para niño</p> | <p data-bbox="314 500 692 652">Retire la cubierta de la sonda, presione y suelte el botón de encendido durante 1 segundo para encender el termómetro. El símbolo "👂" se muestra en la pantalla.</p> <p data-bbox="314 671 695 787">Cambie al modo de medición adulto o niño marcando el interruptor lateral adulto / niño de acuerdo con sus necesidades de medición.</p> <p data-bbox="314 806 674 923">Inserte la sonda de temperatura en una posición adecuada en el canal auditivo. Presione el botón Medir para comenzar una medición.</p> | <p data-bbox="705 637 888 783">Consulte la tabla en la sección "Instrucciones de sonido y color de la luz".</p> |
| Medición de la temperatura de la frente (adulto / niño)   |   |   |



| Visualización de la pantalla   | Instrucciones de uso<br>Estado visualizado   | Sonido y Color de la Luz  |
|--|--|---|
|  <p style="text-align: center;">↓</p>  <p>Temperatura de la frente para adulto</p>  <p>Temperatura de la frente para niño</p> | <p>Coloque la tapa de la sonda, presione y suelte el botón de encendido durante 1 segundo para encender el termómetro. El símbolo "Cabeza"  se muestra en la pantalla.</p> <p>Cambie al modo de medición  para adultos o niños marcando el interruptor lateral adulto / niño de acuerdo con sus necesidades de medición.</p> <p>Apunte el termómetro hacia el centro de la frente. A unos 1-3 cm de la superficie de la piel. Presione y suelte el botón Medir. La temperatura se mostrará en la pantalla.</p> | <p>Consulte la tabla en la sección "Instrucciones de sonido y color de la luz".</p> |
| Medición de temperatura del objeto   |  |   |





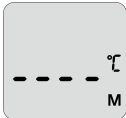
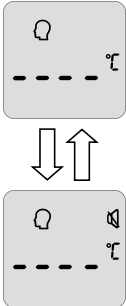

| Visualización de la pantalla   | Instrucciones de uso<br>Estado visualizado   | Sonido y Color de la Luz  |
|--|--|---|
|  <p>The diagram shows two screens. The top screen displays a house icon and a dashed line with a degree symbol. An arrow points down to the second screen, which displays the house icon and the number '26.0' followed by a degree symbol.</p> | <p>Coloque la tapa de la sonda, cambie al modo de medición de objetos presionando el botón Modo. El termómetro ingresa al modo Objeto. El símbolo "Casa"  se muestra en la pantalla.</p> <p>Apunte el termómetro al centro del objeto. Presione y suelte el botón Medir. La temperatura se mostrará en la pantalla.</p> | <p>Consulte la tabla en la sección "Instrucciones de sonido y color de la luz".</p> |
| Fuera del rango de medición  |  |   |
|  <p>The image shows a screen with a bell icon and the letters 'HI' followed by a degree symbol. Below it, the text '(solo por referencia)' is written.</p>  | <p>En modo Oído, una lectura de temperatura de más de 42.0°C (107.6°F)</p> <p>En modo Frente, una lectura de temperatura de más de 42.2°C (108.0°F)</p> <p>En modo Objeto, una lectura de temperatura de más de 100°C (212.0°F)</p>  | <p>Un pitido largo, la luz de fondo es roja.</p>                                    |

| <b>Visualización de la pantalla</b>  | <b>Instrucciones de uso</b><br><b>Estado visualizado</b>  | <b>Sonido y Color de la Luz</b>                  |
|--|---|--|
|  <p>(solo por referencia)</p> | <p>En el modo Oído, una lectura de temperatura de menos de 35.0°C (95.0°F)</p> <p>En modo Frente, una lectura de temperatura de menos de 35.0°C (95.0°F)</p> <p>En modo Objeto, una lectura de temperatura de menos de 0°C (32.0°F)</p> | <p>Un pitido largo, la luz de fondo es roja.</p> |
| Recuperación de lecturas realizadas  |   |  |

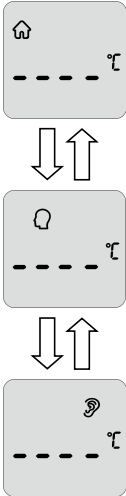
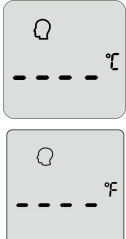
| Visualización de la pantalla  | Instrucciones de uso<br>Estado visualizado  | Sonido y Color de la Luz                     |
|---|---|--|
| <br><br><br> | <p>En un estado de encendido, presione el botón Memoria para ingresar al modo de memoria.</p> <p>Cuando se suelta el botón Memoria, se mostrará 01, seguido de la lectura grabada.</p> <p>Presione el botón Memoria nuevamente para los siguientes datos grabados. Se mostrará 02, seguido de la lectura grabada.</p> <p>Se puede recuperar un máximo de 20 lecturas de temperatura.</p> <p>Cuando se excede el número máximo de registros, se sobrescribirán los primeros datos de memoria.</p> <p>Nota:<br/>01 significa los últimos datos.</p> | <p>Silencioso, la luz de fondo es verde.</p> |
| Sin datos de memoria / Borrar datos de memoria  |   |  |

| Visualización de la pantalla  | Instrucciones de uso<br>Estado visualizado  | Sonido y Color de la Luz   |
|---|---|--|
|  | <p>La pantalla es como se muestra, cuando no hay más datos verificados al recuperar memorias. Retire las 2 baterías secas y después de 10 segundos vuelva a instalar las baterías para borrar todos los datos de la memoria.</p>  | <p>Cuando se vuelve a encender, hay un pitido largo y el color de la luz es verde, luego se vuelve roja.</p> |
| <p>Cambiar entre silenciar y no silenciar</p>                                     |   |  |
|  | <p>En el estado de encendido, mantenga presionado el botón del interruptor de sonido durante aproximadamente 2 segundos para encender o apagar el sonido. Cuando el sonido está activado, sonará una vez y el símbolo de silencio se mostrará cuando el sonido esté apagado.</p> <p>El símbolo  se muestra en el modo Silencio y desaparece en el modo Sin silencio.</p> | <p>Cuando se activa el sonido, suena un pitido largo y el color de la luz es verde.</p>                      |
| <p>Cambiar entre la temperatura del objeto y la temperatura corporal</p>          |   |  |

| Visualización de la pantalla   | Instrucciones de uso<br>Estado visualizado  | Sonido y Color de la Luz                       |
|--|---|--|
|   | <p>Al colocar la cubierta de la sonda, presione el botón Modo para cambiar entre los modos de objeto y frente. El modo de oído (adulto / niño) se activará al quitar la cubierta de la sonda.</p> | <p>Silencio, el color de la luz, es verde.</p> |
| Cambio entre °F/°C   |   |  |
|  | <p>En un estado de encendido, puede cambiar las unidades de medida, cambiando el botón °F / °C.</p>   | <p>Silencio</p>                                |

| Visualización de la pantalla  | Instrucciones de uso<br>Estado visualizado   | Sonido y Color de la Luz                     |
|---|--|--|
| Información de error y batería baja   |  |  |
|  | La temperatura ambiente es superior a 40.0°C (104.0°F) o inferior a 10.0°C (50.0°F).   | Un pitido largo, el color de la luz es roja. |
|  | Se produce un error cuando los datos se leen o escriben en la memoria, o la corrección de temperatura no se completa.                                  | Un pitido largo, el color de la luz es roja. |
|  | Cuando el voltaje de la batería es inferior a $2.4V \pm 0.1V$ , el símbolo de batería baja aparecerá en la pantalla. Por favor reemplace las baterías. | Silencio                                     |

## Medición de la temperatura del oído

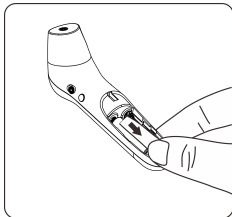
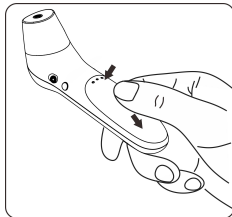

1. Cuando use el termómetro por primera vez, coloque adecuadamente las baterías.

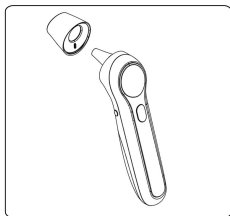

2. Retire la cubierta de la sonda del termómetro antes de medir la

temperatura del oído.



3. Presione el botón de Encendido para encender el termómetro. El símbolo "Oído"  se muestra en la pantalla.
4. Cambie entre los modos "adulto" y "niño" presionando el botón Modo. el símbolo  aparece en modo "niño".
5. Inserte la sonda de temperatura en el canal auditivo.
6. Presione y suelte el botón Medir. La lectura de la temperatura del oído se mostrará en la pantalla al instante.

**Nota:** Niños menores de 1 año: tire de la oreja hacia atrás.

Niños de 1 año a adulto: Tire de la oreja hacia arriba y hacia atrás.

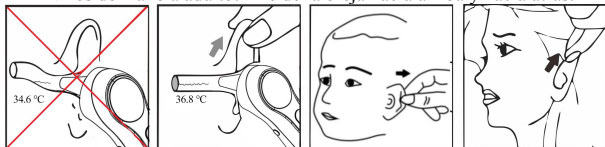

No fuerce el termómetro dentro del canal auditivo. De lo contrario, el canal auditivo puede lesionarse.



Cuando tome la temperatura en un adulto, tire suavemente de la oreja hacia arriba y hacia atrás para asegurarse de que el canal auditivo esté recto, de modo que la sonda de temperatura pueda recibir un rayo infrarrojo desde el tímpano.



Tenga cuidado al tomar temperatura en un niño, cuyo canal auditivo es pequeño.

## Medición de la temperatura de la frente

1. Coloque la tapa en la sonda del termómetro.
2. Presione el botón de Encendido para encender el termómetro. el símbolo "☁" se muestra en la pantalla.
3. Cambie entre los modos "adulto" y "niño" presionando el botón Modo. el símbolo "👶" aparece en modo "niño".
4. Apunte la sonda del termómetro al centro de la frente, a unos "1-3 cm" de la superficie de la piel.

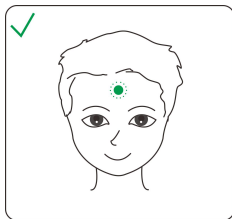
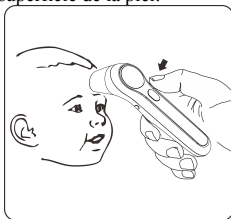

5. Presione y suelte el botón Medir durante 1 segundo. La lectura de temperatura se mostrará en la pantalla al instante.
6. Si no se detecta actividad, el termómetro se apagará automáticamente en 10 segundos.

## Medición de temperatura de objeto

1. Coloque la tapa en la sonda del termómetro.
2. Presione el botón de Encendido para encender el termómetro.
3. Presione el botón Modo, el termómetro ingresa al modo Objeto. El símbolo "🏠" se muestra en la pantalla.
4. Apunte la sonda del termómetro al centro del objeto, a unos "1-3 cm" de la superficie del objeto.
5. Presione y suelte el botón Medir durante 1 segundo. La lectura de temperatura se mostrará en la pantalla al instante.
6. Si no se detecta actividad, el termómetro se apagará automáticamente en 10 segundos.



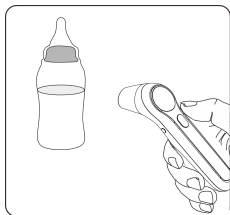

### Después de una medición

- (1) Después de cada medición, puede ingresar al modo de recuperación y consultar lecturas de temperatura anteriores. Para obtener más detalles, consulte "Recuperación de lecturas realizadas" en la tabla anterior.
- (2) Después de cada medición, limpie la sonda de temperatura con un paño suave y coloque el termómetro en un lugar seco y bien ventilado.



Es peligroso hacer un autodiagnóstico o autotratamiento basado en los resultados de medición obtenidos. Para tales fines, consulte a un médico..

### Solución de problemas

| Problema                      | Causa posible                                     | Solución  |
|-------------------------------|---|---|
| El termómetro no se enciende. | Batería baja                                      | Cambia las baterías.  |
|                               | Las polaridades de las baterías están invertidas. | Asegúrese de que las baterías estén instaladas correctamente. |
|                               | El termómetro está                                | Póngase en contacto   |

|  |  |   |
|--|--|---|
|  | dañado.  | con el fabricante.  |
| Se muestra "Er1".  | La temperatura ambiente es inferior a 10.0°C (50.0°F) o superior a 40.0°C (104.0°F).           | Realice una medición a una temperatura ambiente entre 10.0°C (50.0°F) y 40.0°C (104.0°F). |
| La lectura de temperatura es más baja que el rango de temperatura corporal típico. | La lente de la sonda de temperatura está sucia.  | Limpie la lente con un bastoncillo de algodón.  |
|  | La sonda del termómetro no está alineada con el tímpano.                                       | Vuelva a colocar la sonda del termómetro para que quede alineada con el tímpano.          |
|  | El termómetro se usa dentro de los 30 minutos posteriores a la extracción de un ambiente frío. | Espere más de 30 minutos después de que el termómetro se traslade al entorno de medición. |
| La lectura de temperatura es más alta que el rango de temperatura corporal típico. | La sonda de temperatura está dañada.   | Póngase en contacto con el fabricante.  |

## Especificaciones

|                     |                      |
|---------------------|----------------------|
| Nombre del producto | Termómetro infrarojo |
| Modelo del Producto | JPD-FR300            |

|                               |   |
|-------------------------------|---|
| Modo de suministro de energía | Fuente de alimentación interna  |
| Tensión de funcionamiento     | DC 3V   |
| Modelo de batería             | AAA x 2   |
| Modo operativo                | Funcionamiento continuo   |
| Monitor                       | Segmento LCD  |
| Medir el tiempo               | Alrededor de 1 segundo  |
| Tiempo de latencia            | Alrededor de 3 segundos   |
| Rango de medición             | Modo de frente: 35.0°C–42.2°C (95.0°F–108.0°F)<br>Modo de oído: 35.0°C–42.0°C (95.0°F–107.6°F)<br>Modo de objeto: 0.0°C–100.0°C (32.0°F–212.0°F)  |
| Exactitud (laboratorio)       | Modo de frente: $\pm 0.2^{\circ}\text{C}$ ( $\pm 0.4^{\circ}\text{F}$ )<br>Modo de oído: $\pm 0.2^{\circ}\text{C}$ ( $\pm 0.4^{\circ}\text{F}$ )<br>Modo de objeto: $\pm 1.0^{\circ}\text{C} / \pm 2.0^{\circ}\text{F}$ |
| Resolución                    | 0.1°C (0.1°F)   |
| Memoria                       | 20 lecturas de temperatura  |
| Alerta de batería baja        | El símbolo de batería baja se muestra si el voltaje de alimentación es inferior a 2.4 V $\pm$ 0.1 V   |
| Apagado automático            | El termómetro se apaga automáticamente si no se usa en 10 $\pm$ 1 segundos.   |
| Dimensiones exteriores (mm)   | 155.9 * 40.2 * 49.2 mm  |
| Peso (gramos)                 | Termómetro (con baterías): 90g  |
| Condiciones Ambientales       | Temperatura: 10°C ~ 40°C (50.0°F - 104.0°F)   |
|                               | Humedad: 15% - 95% HR, sin condensación   |
|                               | Presión atmosférica: 86 - 106 kPa   |

# JUMPER

---



Shenzhen Jumper Medical Equipment Co., Ltd.  
Address: D Building, No. 71, Xintian Road, Fuyong Street,  
Baoan, Shenzhen, Guangdong, China  
Tel:+86-755-26696279  
Fax:+86-755-26852025  
Website: <http://www.jumper-medical.com>